

# ***INSTRUCTION MANUAL***

## ***121 INDICATOR***

### **TABLE OF CONTENTS**

#### **1. DESCRIPTION**

1.1 Unit Description .....	4
1.2 Unit Features .....	4
1.3 Specifications .....	5

#### **2. INSTALLATION**

2.1 General Mounting Hints .....	9
2.2 Mounting Diagrams .....	9

#### **3. APPLICATIONS**

3.1 Liquid Volume .....	10
3.2 Corrected Liquid Volume .....	11
3.3 Liquid Mass .....	12
3.4 Batching .....	13

#### **4. WIRING**

4.1 Typical Batcher Wiring .....	14
4.2 Typical Rate/Total Wiring .....	14

#### **5. UNIT OPERATION**

5.1 Front Panel Operation Concept for Run Mode .....	15
5.2 General Operation .....	16
5.3 Ratemeter/Totalizer Operation .....	16
5.3.1 Password Protection for Rate/Total mode .....	16
5.3.2 Relay Operation in Rate/Total mode .....	16
5.3.3 Pulse Output in Rate/Total mode .....	16
5.3.4 Analog Output in Rate/Total mode .....	16
5.3.5 RS-232 Serial Port Operation in Rate/Total mode .....	16
5.4 Batcher Operation .....	17
5.4.1 Batcher Configuration .....	17
5.4.2 Password Protection for Batcher mode .....	18
5.4.3 Relay Operation in Batcher mode .....	18
5.4.4 Pulse Output in Batcher mode .....	19
5.4.5 Analog Output in Batcher mode .....	19
5.4.6 RS-232 Serial Port Operation in Batcher mode .....	19

#### **6. PROGRAMMING**

6.1 Front Panel Operation Concept for Program Mode .....	20
6.2 EZ Setup .....	21
6.3 Setup Menus .....	22
6.4 Setup Sub-Menus .....	23
6.4.1 SELECT EZ SETUP .....	23
6.4.2 INSTRUMENT TYPE .....	23
6.4.3 SELECT FLOW EQUATION .....	24
6.4.4 SETUP INDICATORS (Total) .....	24
6.4.5 SETUP INDICATORS (Density) .....	24

6.4.6 SETUP INDICATORS (Rate).....	25
6.4.7 SETUP INDICATORS (Temperature).....	25
6.4.8 SETUP FLOW INPUT (Pulse - Ain & PS (A=B)).....	26
6.4.9 SETUP FLOW INPUT (Pulse - Quadrature, Qx1 or Qx2).....	27
6.4.10 SETUP FLOW INPUT (Analog).....	28
6.4.11 SETUP AUX INPUT.....	29
6.4.12 SET FLUID PROPERTIES.....	30
6.4.13 SETUP PULSE OUTPUT .....	30
6.4.14 SETUPANALOG OUTPUT.....	31
6.4.15 SETUP RELAYS.....	31
6.4.16 SETUP CONTROL INPUTS(RATE/TOTAL).....	33
6.4.17 SETUP CONTROL INPUTS(BATCH).....	33
6.4.18 SETUP REALTIME CLOCK(Time).....	34
6.4.19 SETUP REALTIME CLOCK(Date).....	34
6.4.20 SERIAL USAGE .....	35
6.4.21 SET DATALOG/PRINT(Configure) .....	36
6.4.22 SET DATALOG/PRINT (Select_list).....	37
6.4.23 ADMINISTRATIVE SETUP.....	37
6.4.24 SETUP NETWORK CARD.....	38
<b>7. PRINCIPLE OF OPERATION</b>	
7.1 General.....	39
7.3 Flow Equations.....	39
7.4 Calculating the Expansion Factor.....	41
7.6 Linearization Table .....	42
7.6.1 Linearization Table General Information .....	42
7.6.2 Linearization Table for Pulse Inputs.....	42
7.6.3 Linearization Table for Analog Inputs.....	42
<b>8. TEST, SERVICE and MAINTENANCE</b>	
8.1 Test Menus.....	43
8.2 Test Sub-Menus .....	44
8.2.1 Audit Trail.....	44
8.2.2 Error History.....	44
8.2.3 Print System Setup.....	44
8.2.4 Keypad test .....	45
8.2.5 Display test .....	45
8.2.6 Calibrate CH1 0mA.....	46
8.2.7 Calibrate CH1 20mA.....	46
8.2.8 Calibrate CH2 0mA.....	47
8.2.9 Calibrate CH2 20mA.....	47
8.2.10 Calibrate CH1 0V.....	48
8.2.11 Calibrate CH1 10V .....	48
8.2.12 Calibrate CH2 0V.....	49
8.2.13 Calibrate CH2 10V.....	49
8.2.14 Calibrate 100 ohm RTD.....	49
8.2.15 Calibrate 4mA Out.....	50
8.2.16 Calibrate 20mA Out.....	50
8.2.17 Analog In Test.....	50

8.2.18 Pulse input test . . . . .	51
8.2.19 Analog out test . . . . .	51
8.2.20 Excitation out test . . . . .	51
8.2.21 Pulse out test . . . . .	52
8.2.22 Relay test . . . . .	52
8.2.23 Control input test . . . . .	52
8.2.24 Battery Voltage test . . . . .	53
8.2.25 Data logger utility . . . . .	53
8.3 Internal Fuse Replacement . . . . .	54
<b>9. RS-232 SERIAL PORT</b>	
9.1 RS-232 Serial Port Description . . . . .	55
9.2 Instrument Setup by PC Over Serial Port . . . . .	55
9.3 Operation of Serial Communication Port with Printers . . . . .	55
9.4 121 Series RS-232 Port Pinout . . . . .	55
<b>10. RS-485 SERIAL PORT</b>	
<b>11. FLOW COMPUTER SETUP SOFTWARE</b>	
11.1 System Requirements . . . . .	56
11.2 Cable and Wiring Requirements . . . . .	56
11.3 Installation for Windows™3.1 or 3.11 . . . . .	56
11.4 Using the Flow Computer Setup Software . . . . .	56
11.5 File Tab . . . . .	57
11.6 Setup Tab . . . . .	57
11.7 View Tab . . . . .	58
11.8 Misc. Tab . . . . .	58
<b>12. GLOSSARY OF TERMS</b>	
12 Glossary Of Terms . . . . .	59
<b>13. DIAGNOSIS AND TROUBLESHOOTING</b>	
13.1 Response of 121 Series on Error or Alarm . . . . .	63
13.2 Diagnosis Flow Chart and Troubleshooting . . . . .	64
13.3 Error & Warning Messages: . . . . .	65
13.3.1 Sensor/Process Alarms . . . . .	65
13.3.2 Self Test Alarms . . . . .	66
<b>APPENDIX A</b>	
Setup Menus . . . . .	68

*DO NOT ATTEMPT TO INSTALL OR START FLOWMETER  
WITHOUT READING THIS ENTIRE MANUAL*

121-000-350 © 2001 Max Machinery, Inc.

Max Machinery, Inc. reserves the right to make changes to the product in this Instruction Manual to improve performance, reliability, or manufacturability. Consequently, contact MMI for the latest available specifications and performance data.

Although every effort has been made to ensure accuracy of the information contained in this Instruction Manual, MMI assumes no responsibility for inadvertent errors

# General Description

## 1. Description

### 1.1 Unit Description:

The Max Model 121 Flow Computer satisfies the instrument requirements for a variety of flowmeter types in liquid applications. Multiple flow equations and instrument functions are available in a single unit with many advanced features.

The alphanumeric display shows measured and calculated parameters in an easy to understand format. Single key direct access to measurements and display scrolling is supported.

The versatility of the Model 121 permits a wide measure of versatility within the instrument package. The various hardware inputs and outputs can be “soft” assigned to meet a variety of common application needs. The user “soft selects” the usage of each input/output while configuring the instrument. Consider the following illustrative examples.

The isolated analog output can be chosen to follow volume flow, corrected volume flow, mass flow, temperature, or density by means of a menu selection. Most hardware features are assignable by this method.

The user can assign the standard RS-232 Serial Port for data logging, transaction printing, or for connection to a modem for remote meter reading.

### 1.2 Unit Features:

The Model 121 Flow Computer offers the following features:

- Multiple Instrument Functions
- Menu Selectable Hardware & Software Features
- Two Line VFD Display
- Isolated Outputs Standard
- Versatile RS-232 Port Standard
- DIN Enclosure with Two Piece Connector
- Advanced Batching Features

# Specifications

## Specifications:

### Environmental

Indoor Use

Altitude up to 2000m

Operating Temperature: 0C to +50C

Storage Temperature: -40C to +85C

Maximum Relative Humidity : 80% for temperatures up to 31C decreasing linearly to 50% RH at 40C

Main supply voltage fluctuations not to exceed  $\pm 10\%$  of the nominal voltage

Transient overvoltage according to INSTALLATION CATEGORY II (see UL 3101-1 Annex J)

POLLUTION DEGREE 2 in accordance with

IEC 664 (see 3.7.3)

Materials: UL, CSA, VDE approved

**Approvals:** CE Approved Light Industrial,

UL File #: E192404

CSA Pending

### Display

Type: 2 lines of 20 characters

Type: VFD

Character Size: 0.3" nominal

User selectable label descriptors and units of measure

### Keypad

Keypad Type: Membrane Keypad

Keypad Rating: Sealed to NEMA 4

Number of keys: 16

### Enclosure

Size: See Dimensions on page 9

Depth behind panel: 6.5" including mating connector

Type: DIN

Materials: Plastic, UL94V-0, Flame retardant

Bezel: Textured per matt finish

Equipment Labels: Model, safety, and user wiring

### Power Input

The factory equipped power option is internally fused.

An internal line to line filter capacitor is provided for added transient suppression.

121-200: 110VAC: 85 to 127 Vrms, 50/60 Hz

121-201: 12VDC: 10.5 to 14 VDC

### Control Inputs

Switch Inputs are menu selectable for Start, Stop, Reset, Lock, Inhibit, Alarm Acknowledge, Print or Not Used.

Control Input Specifications

Input Scan Rate: 10 scans per second

Logic 1: 4 - 30 VDC

Logic 0: 0 - 0.8 VDC

Transient Suppression: 500 V fast transient  
(Capacitive Clamp)

Input Impedance: 100 K

Control Activation: Positive Edge or Pos. Level based on product definition

### Flow Inputs:

#### Analog Input:

Ranges

Voltage: 0-10 VDC, 0-5 VDC, 1-5 VDC

Current: 4-20 mA, 0-20 mA

Basic Measurement Resolution: 16 bit

Update Rate: 5 updates/sec minimum

Automatic Fault detection: Signal over/under-range, Current Loop Broken

Calibration: Self Calibration and Auto-zero continuously

Extended calibration: Learns Zero and Full Scale of each range using special test mode.

Fault Protection:

Fast Transient: 500 V Protection

(Capacitive Clamp)

Reverse Polarity: No ill effects

Over-Voltage Limit: 50 VDC Over voltage protection

Over-Current Protection: Internally current limited

Protected to 24 VDC.

#### Compensation Input

The compensation input is menu selectable for temperature, density or not used.

Operation: Ratiometric

Accuracy: 0.01% FS

Thermal Drift: Less than 100 ppm/ $^{\circ}$ C

Basic Measurement Resolution: 16 bit

Update Rate: 1 update/sec minimum

Automatic Fault detection:

Signal Over-range/under-range

Current Loop Broken

RTD short

RTD open

Fault mode to user defined default settings

Transient Protection: 500 V (Capacitive Clamp)

Reverse Polarity: No ill effects

Over-Voltage Limit (Voltage Input): 50 VDC

Available Input Ranges

Voltage: 0-10 VDC, 0-5 VDC, 1-5 VDC

Current: 4-20 mA, 0-20 mA

Resistance: 100 Ohms DIN RTD

100 Ohm DIN RTD (DIN 42-760, BS 1904):

Three Wire Lead Compensation

Internal RTD linearization learns ice point resistance

1 mA Excitation current with reverse polarity protection

Temperature Resolution: 0.01 C

#### Excitation Voltage

110/220 VAC Powered Units

Menu Selectable: 5, 12 or 24 VDC @ 100mA

12 VDC Powered Units

5 VDC @ 100mA

# Specifications

## Pulse Inputs:

Number of Flow Inputs: one  
Configurations supported: single input with or without quadrature (menu selectable)  
Input Impedance: 10 K nominal  
Pullup Resistance: 10 K to 5 VDC (menu selectable)  
Pull Down Resistance: 10 K to common  
Trigger Level: (menu selectable)  
High Level Input  
    Logic On: 3 to 30 VDC  
    Logic Off: 0 to 1 VDC  
    Low Level Input (mag pickup)  
    Selectable sensitivity: 10 mV & 100 mV  
Minimum Count Speed: User selectable  
Maximum Count Speed: Selectable: 0 to 20kHz  
Overvoltage Protection: 50 VDC  
Fast Transient: Protected to 500 VDC (Capacitive Clamp)

## Relay Outputs

The relay outputs are menu assignable to (individually for each relay) Low Rate Alarm, Hi Rate Alarm, Prewarn Alarm, Preset Alarm, Pulse Output (pulse options) or General purpose warning (security).  
Number of relays: 2  
Contact Style: Form C contacts  
Contact Ratings:  
    250 VAC @ 5 amps  
    30 VDC @ 5 amps  
Fast Transient Threshold: 1000 V  
Serial Communication

The serial port can be used for printing, datalogging, modem connection and communication with a computer.

## Analog Output

The analog output is menu assignable to correspond to the Uncompensated Volume Rate, Corrected Volume Rate, Mass Rate, Temperature, Density, Volume Total, Corrected Volume Total or Mass Total.  
Type: Isolated Current Sourcing  
Isolated I/P/C: 500 V  
Available Ranges: 4-20 mA, 0-20 mA  
Resolution: 12 bit  
Accuracy: 0.05% FS at 20 Degrees C  
Update Rate: 1 update/sec minimum  
Temperature Drift: Less than 200 ppm/°C  
Maximum Load: 1000 ohms (at nominal line voltage)  
Compliance Effect: Less than .05% Span  
60 Hz rejection: 40 dB minimum  
EMI: No effect at 3 V/M  
Calibration: Operator assisted Learn Mode  
Averaging: User entry of DSP Averaging constant to cause a smooth control action.

## Isolated Pulse output

The isolated pulse output is menu assignable to Uncompensated Volume Total, Compensated Volume Total or Mass Total.  
Isolation I/O/P: 500 V  
Pulse Output Form: Open Collector  
Maximum On Current: 125 mA  
Maximum Off Voltage: 30 VDC  
Saturation Voltage: 1.0 VDC  
Maximum Off Current: 0.1 mA  
Pulse Duration: User selectable  
Pulse output buffer: 8 bit  
Pulse Rate Averaging: Standard  
Fault Protection  
Reverse polarity: Shunt Diode  
Transient Protection: 500 VDC (Capacitive Clamp)

## Operating Mode

The Flow Computer can be thought of as making a series of measurements of flow, temperature/density sensors and then performing calculations to arrive at a result(s) which is then updated periodically on the display. The analog output, the pulse output, and the alarm relays are also updated. The cycle then repeats itself.

- Step 1: Update the measurements of input signals-  
Raw Input Measurements are made at each input using equations based on input signal type selected. The system notes the "out of range" input signal as an alarm condition.
- Step 2: Compute the Flowing Fluid Parameters-The temperature, viscosity, and density equations are computed as needed based on the flow equation and input usage selected by the user.
- Step 3 : Compute the Volumetric Flow-Uncompensated flow is the term given to the flow in volume units. The value is computed based on the flowmeter input type selected and augmented by any performance enhancing linearization that has been specified by the user.
- Step 4: Compute the Corrected Volume Flow at Reference Conditions-In the case of a corrected liquid volume flow calculation, the corrected volume flow is computed as required by the selected compensation equation.
- Step 5 : Compute the Mass Flow-All required information is now available to compute the mass flow rate as volume flow times density.
- Step 6: Check Flow Alarms-The flow alarm functions have been assigned to one of the above flow rates during the setup of the instrument. A

comparison is now made by comparing the current flow rates against the specified hi and low limits.

- Step 7: Compute the Analog Output-This designated flow rate value is now used to compute the analog output.
- Step 8: Compute the Flow Totals by Summation-A flow total increment is computed for each flow rate. This increment is computed by multiplying the respective flow rate by a time base scaler and then summing. The totalizer format also includes provisions for total rollover.
- Step 9: Total Preset Comparisons-The total associated with a preset function is then compared against the corresponding preset value and any required control actions taken.
- Step 10: Pulse Output Service-The pulse output is next updated by scaling the total increment which has just been determined by the pulse output scaler and summing it to any residual pulse output amount.
- Step 11: Update Display and Printer Output-The instrument finally runs a task to update the various table entries associated with the front panel display and serial outputs.

### Setup Mode

The setup mode is password protected by means of a numeric lock out code established by the user. In addition, a secret, manufacturer's numeric unlock entry sequence is available.

The system also provides a minimum implementation of an "audit trail" which tracks significant setup changes to the unit. This feature is increasingly being found of benefit to users or simply required by Weights and Measurement Officials in systems used in commerce, trade, or "custody transfer" applications.

A Worksheet is provided to assist the user in setting up the instrument. In addition, a software program is available which runs on a PC using a RS-232 Serial connection to the Flow Computer. Illustrative examples may be downloaded in this manner.

The setup mode has numerous subgrouping of parameters needed for flow calculations. There is a well conceived hierarchy to the setup parameter list. Selections made at the beginning of the setup affect offerings further down in the lists.

In the setup mode, the flow computer activates the correct setup variables based on the instrument configuration, the flow equation, and the hardware selections made for the compensation transmitter type, the flow transmitter type, and meter enhancements (linearization) options selected. All required setup parameters are enabled. All setup parameters not required are suppressed.

A help line prompt is provided for each entry. In addition a help message is available which may be accessed by depressing the "HELP" key.

In the setup mode selections, several parameters are required to be input by the operator since these parameters are blank when the unit is received. The user will be prompted for these necessary values for his application. A blank parameter will prevent the user from entering the run mode and a suitable warning message will be issued.

Also note that in the setup mode there are parameter selections which have preassigned industry standard values. The unit will assume these values unless they are modified by the user.

Most of the process input variables have available a "default" or emergency value which must be entered. These are the values that the unit assumes when a malfunction is determined to have occurred on the corresponding input.

**Hint:** It is possible to enter in a nominal constant value for temperature or density, or analog flow inputs by placing the desired nominal value into both the lo and hi values. This is also a convenience when performing bench top tests without simulators.

### Maintenance Mode:

The Maintenance Mode of the 121 Series is the Test and Calibration Mode for the device. This mode provides a number of specialized utilities required for factory calibration, instrument checkout on start-up, and periodic calibration documentation.

A password is required to gain access to this specialized mode of operation. Normally

## Specifications

quality, calibration, and maintenance personnel will find this mode of operation very useful. It is also useful for factory testing.

Many of these tests may be used during start-up of a new system. Inputs signals may be read, and output signals may be exercised to verify the electrical interconnects before the entire system is put on line.

The following action items may be performed in the Maintenance Mode:

- Print Calibration/Maintenance Report
- Examine Audit Trail
- Perform Keypad Checkout
- Perform Display Checkout
- Perform Pulse Input Checkout
- Perform Pulse Output Checkout
- Perform Control Input Checkout
- Perform Relay Output Checkout
- Perform Analog Input Checkout
- Perform Analog Output Checkout
- Calibrate Analog Inputs using the Learn Feature
- Calibrate Analog Output using the Learn Feature
- Battery Check

Note that a calibration of the analog input/output will advance the audit trail counters since it effects the accuracy of the system.

### **RS-232 Serial Port**

The 121 Series has a general purpose RS-232 Port which may be used for any one of the following purposes:

- Transaction Printing
- Data Logging Internal Datalog Dumps
- Computer Communication Link
- Configuration by Computer
- Print System Setup
- Print Calibration/Malfunction History
- Remote Control

### **Instrument Setup by PC's over Serial Port**

A Diskette program is provided with the 121 Series that enables the user to rapidly configure the indicator using a Personnel Computer. Included on the diskette are common instrument applications which may be used as a starting point for your application. This permits the user to have an excellent starting point and helps speed the user through the instrument setup.

### **Operation of Serial Communication Port with Printers**

121 Series's RS-232 channel supports a number of operating modes. One of these modes is intended to support operation with a printer in metering applications requiring transaction printing, data

logging and/or printing of calibration and maintenance reports.

For transaction printing, the user defines the items to be included in the printed document. The user can also select what initiates the transaction print generated as part of the setup of the instrument. The transaction document may be initiated via a front panel key depression, a remote contact closure, or upon completion of a batch.

In data logging, the user defines the items to be included in each data log as a print list. The user can also select when or how often he wishes a data log to be made. This is done during the setup of the instrument as either a time of day or as a time interval between logging.

The system setup and maintenance report lists all the instrument setup parameters and usage for the current instrument configuration. In addition, the Audit trail information is presented along with a status report listing any observed malfunctions which have not been corrected.

The user initiates the printing of this report at a designated point in the menu by pressing the print key on the front panel.



## 2.1 General Mounting Hints:

The 121 Series Flow Computer should be located in an area with a clean, dry atmosphere which is relatively free of shock and vibration. The unit is installed in a 5.43" (138mm) wide by 2.68" (68mm) high panel cutout. (see Mounting Dimensions)  
To mount the Flow Computer, proceed as follows:

### Mounting Procedure:

- Prepare the panel opening.
- Slide the unit through the bezel adaptor and gasket.
- Push the unit through the panel cutout until it touches the panel.
- Install the screws (provided) in the mounting bracket and slip the bracket over the rear of the case until it snaps in place.
- Tighten the screws firmly to seat the bezel against the panel.

### Termination Connectors:

Minimum Wire Gauge: 22 AWG  
Maximum Wire Gauge: 14 AWG  
Voltage/current limits are limited by unit specifications.

### Permanently Connected Equipment:

#### UL 3101-1, Section 6.12.2.1 specifies that:

- A switch or circuit breaker shall be included in the building installation;
- It shall be in close proximity to the equipment and within easy reach of the OPERATOR;
- It shall be marked as the disconnecting device for the equipment.

Ensure that the switch or circuit breaker chosen is suitable for the power requirements of the unit.

## 2.2 Mounting Diagrams:

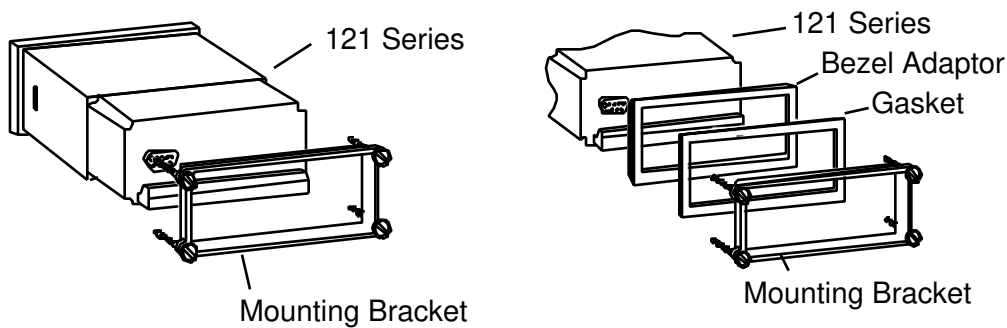

### Dimensions

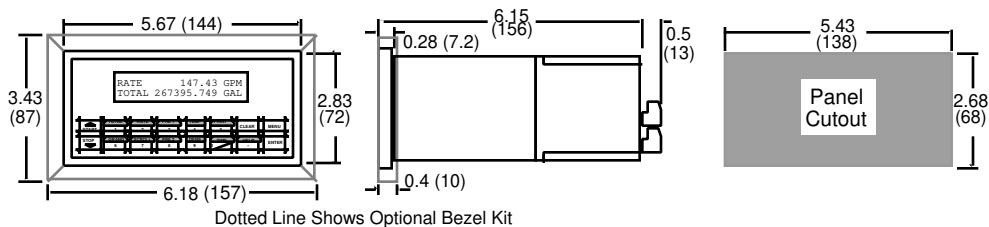

# Applications

## 3. Applications

### 3.1 Liquid Volume

#### Measurements:

A flowmeter measures the actual volume in a liquid line. A temperature sensor can also be installed to correct for liquid thermal expansion (see 3.2 Corrected Volume).

#### Calculations:

- For Flowmeters with Pulse Outputs, Volume flow is calculated using the flowmeter frequency output and the user entered K-Factor.
- For Flowmeters with Analog Transmitters, Volume flow is calculated using the measured flowmeter signal and the user entered scale settings.

#### Output Results:

- Display Results  
Flow Rate, Resettable Total, Non-Resettable Total
- Analog Output  
Rate or Total
- Pulse Output  
Total
- Relay Outputs  
Rate or Total Alarms

#### Applications:

The Flow Computer can monitor actual volume flow and total of any liquid. Flow alarms are provided via relays and datalogging is available via analog (4-20mA) and serial outputs.

#### Liquid Volume Illustration

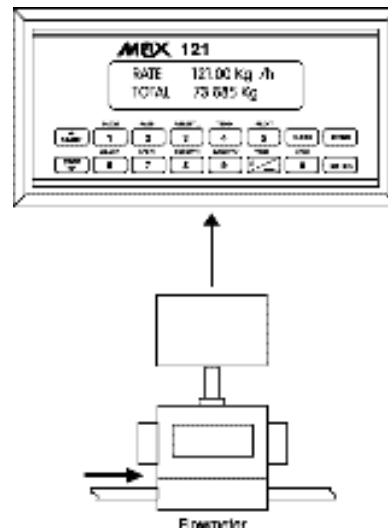

#### Calculations

##### Pulse Input; Average K-Factor

$$\text{Volume Flow} = \frac{\text{input frequency} \cdot \text{time scale factor}}{\text{K-Factor}}$$

##### Analog Input; Linear

$$\text{Volume Flow} = \% \text{ input} \cdot \text{Full Scale Flow}$$

### 3.2 Corrected Liquid Volume

#### Measurements:

A flowmeter measures the actual volume in a liquid line. A temperature sensor is installed to correct for liquid thermal expansion.

#### Calculations:

- Corrected Volume is calculated using the flow and temperature inputs as well as the thermal expansion coefficient stored in the flow computer. Use the "SET FLUID PROPERTIES" submenu to define reference temperature and density values for standard conditions.

#### Output Results:

- Display Results  
Flow Rate, Resettable Total, Non-Resettable Total, Temperature, Density
- Analog Output  
Rate, Total, Temperature or Density
- Pulse Output  
Total
- Relay Outputs  
Rate, Total or Temperature Alarms

#### Applications:

Monitoring corrected volume flow and total of any liquid. Flow alarms are provided via relays and datalogging is available via analog (4-20mA) and serial outputs.

#### Corrected Liquid Volume Illustration

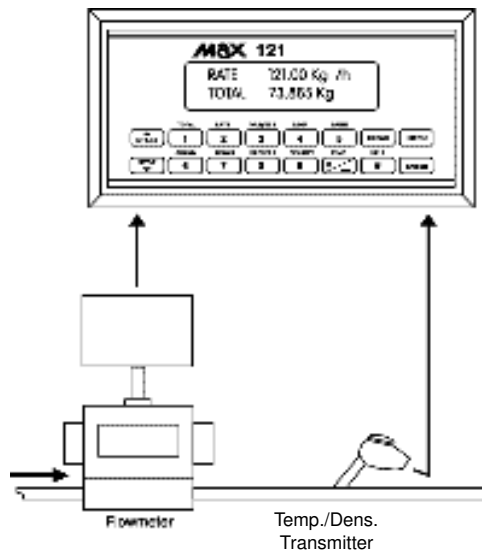

#### Calculations Volume Flow

As calculated in section 3.1

#### Corrected Volume Flow (Temp. Transmitter)

$$\text{Corrected Volume Flow} = \text{vol. flow} \cdot (1 - \text{Therm.Exp.Coef.} \cdot (T_f - T_{ref}))^2$$

# Liquid Mass

## 3.3 Liquid Mass

### Measurements:

Actual volume is measured by the flow element (DP transmitter, Flowmeter). Temperature is measured by the temperature transmitter. A density transmitter can be used for direct density measurements.

### Calculations:

- The density and mass flow are calculated using the reference density and the thermal expansion coefficient of the liquid (see "SET FLUID PROPERTIES" submenu)

### Output Results:

- Display Results  
Flow Rate, Resettable Total, Non-Resettable Total, Temperature, Density
- Analog Output  
Rate, Total, Temperature or Density
- Pulse Output  
Total
- Relay Outputs  
Rate, Total or Temperature Alarms

### Applications:

Monitoring mass flow and total of any liquid. Flow alarms are provided via relays and datalogging is available via analog (4-20mA) and serial outputs.

## Liquid Mass

### Illustration

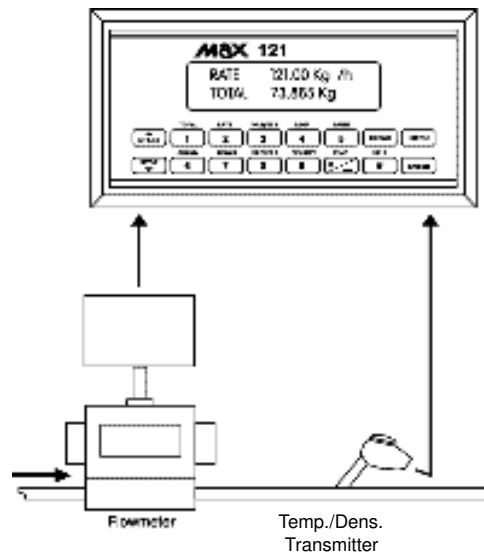

### Calculations

#### Volume Flow

As calculated in section 3.1

#### Mass Flow

Mass Flow = volume flow • density

### 3.4 Batching

#### Measurements:

A flowmeter measures the actual volume in a liquid line. A temperature sensor can also be installed to correct for liquid thermal expansion (see 3.2 Corrected Volume).

#### Calculations:

- For Flowmeters with Pulse Outputs, Volume flow is calculated using the flowmeter frequency output and the user entered K-Factor.
- For Flowmeters with Analog Transmitters, Volume flow is calculated using the measured flowmeter signal and the user entered scale settings.
- Corrected Volume is calculated using the flow and temperature inputs as well as the thermal expansion coefficient stored in the flow computer.

#### Output Results:

- Display Results  
Flow Rate, Batch Total, Non-Resettable Total, Temperature, Density
- Analog Output  
Rate, Total, Temperature or Density
- Pulse Output  
Total
- Relay Outputs  
Batch Total, Rate, or Temperature Alarms

#### Applications:

Batching and monitoring flow and total of any liquid. Batching is accomplished via relays and datalogging is available via analog (4-20mA) and serial outputs.

#### Batching Illustration

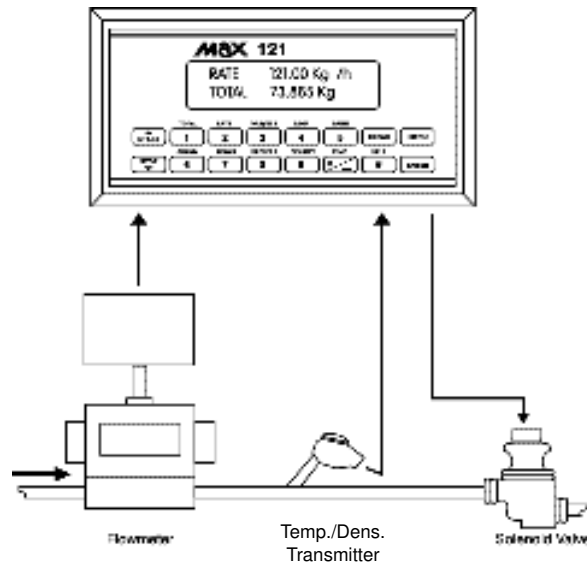

#### Calculations

##### Volume Flow

As calculated in section 3.1

##### Corrected Volume Flow (Temp. Transmitter)

$$\text{Corrected Vol. Flow} = \text{volume flow} \cdot (1 - \text{Therm.Exp.Coef.} \cdot (T_f - T_{ref}))^2$$

# Wiring

## 4 WIRING

### 4.1 Typical Batcher Wiring: Batcher Wiring

For Model 121-500 Indicators, please refer to drawing #121-500-200, on page 67, for interface cable pin information

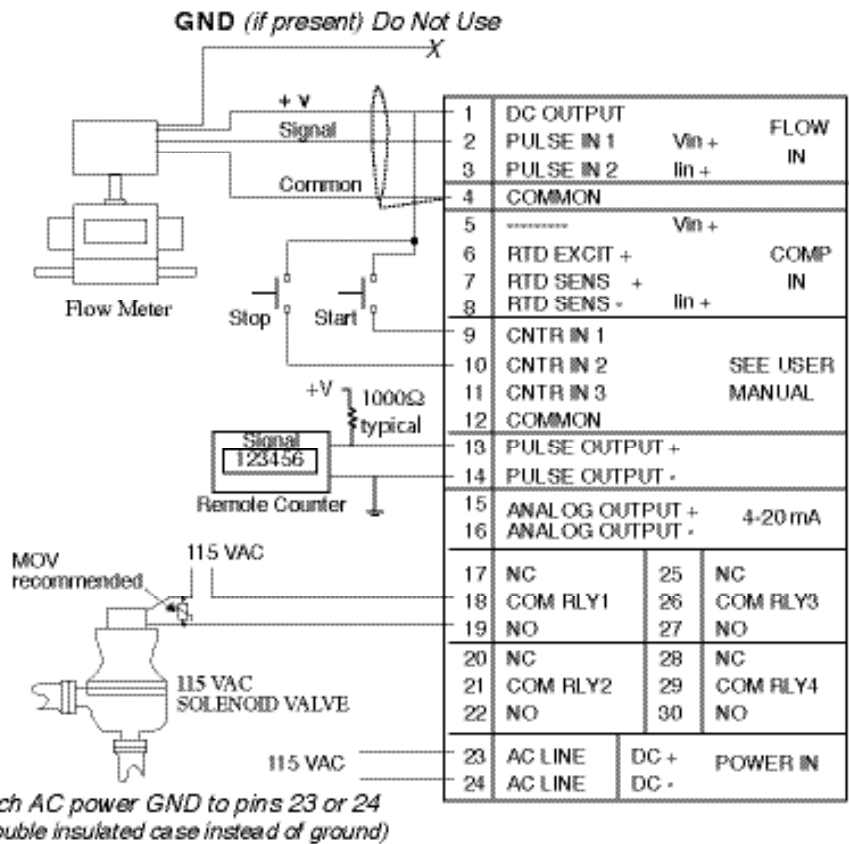

### 4.2 Typical Rate/Total Wiring: Rate / Total Wiring

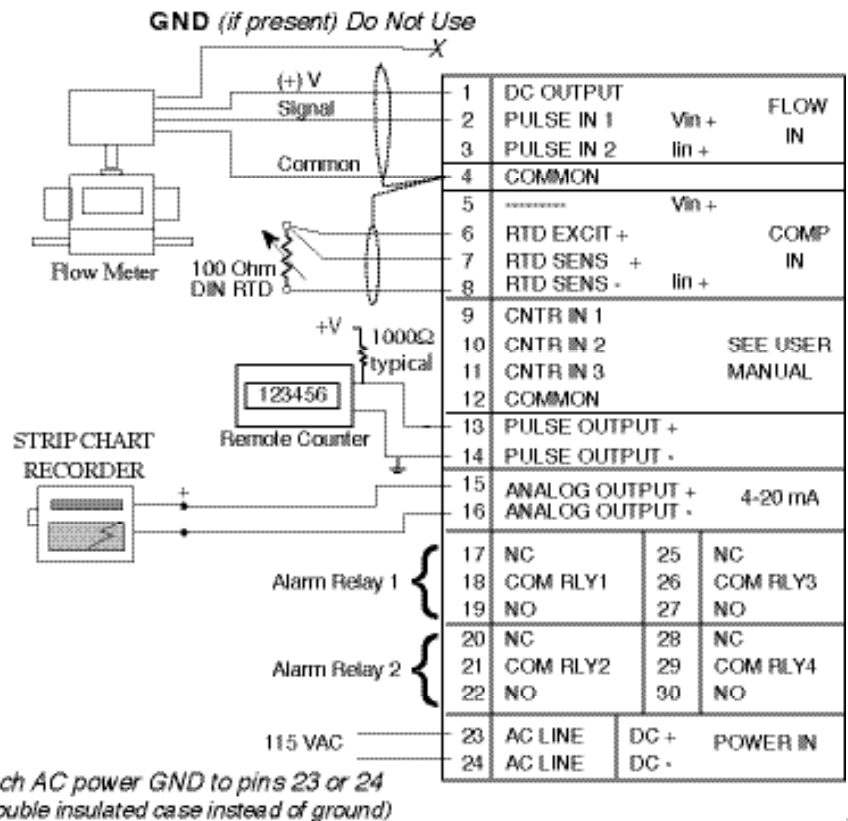

## **5. UNIT OPERATION**

### **5.1 Front Panel Operation Concept for Run Mode**

The 121 Series is fully programmable through the front panel. Please review the following usage summary before attempting to use the instrument.

#### **HELP**

On-line help is provided to assist the operator in using this product. The help is available during RUN and SETUP modes simply by pressing the HELP key. The HELP key is used to enter decimals when entering numeric values.

#### **FUNCTION KEYS**

In the RUN mode, several keys have a special, direct access feature, to display an item of interest (i.e. RATE, TOTAL, PRESET 1, etc.). Press the key to view your choice. Press the SCROLL key to return to scrolling display.

#### **CLEARING TOTALIZER**

To clear the total, you must press the TOTAL Function Key 3 times. You will be asked to verify this action. The operator will be prompted to enter password if the unit is locked. NOTE: In the Batcher Mode, simply press the CLEAR key to reset the total (the batcher must be stopped or finished batching). It is not necessary to press the TOTAL Function Key first.

#### **CLEARING GRAND TOTAL**

To clear the grand total, you must press the GRAND Function Key 3 times. You will be asked to verify this action. The supervisor will be prompted to enter the supervisor password if the unit is locked.

#### **PRESET KEYS**

In the RUN mode, PRESET 1 & PRESET 2 keys are used to view and/or change the preset setpoints. To view the Presets, simply press the desired Preset key. Rapidly press the Preset keys 3 times, then press the Clear key for direct editing of the preset setpoints.

#### **SCROLL**

Rapidly press the Scroll key twice to setup a display list. Press the CLEAR key to remove old scroll list. Press the function key for the item you wish to add. Use the arrow keys to assign the line.

#### **PRINT**

The PRINT key is used to print on demand. When the PRINT key is pressed, a user defined list of data (TOTAL, RATE, PRESET 1, etc.) is sent to the RS-232 port. A timed message of "PRINTING" will be displayed to acknowledge the print request.

#### **SPECIAL BATCHING KEYS**

The START and STOP keys are used only when batching to start and stop batches. The CLEAR key will clear the total without first pressing the TOTAL key (unit must be stopped). All other keys work the same in both Rate/Total mode and Batch mode. The Start and Stop keys operation are set by the control input settings. The Start options are: START or RESET/START. The Stop options are: STOP or STOP/RESET.

#### **MENU KEY**

The MENU key is used to enter the Setup and Test modes. Press the MENU key to enter the Setup and Test modes. (See section 6 for Setup mode, section 8 for Test mode). The MENU key is used as "escape" in Setup and Test Programming. Pressing the MENU key while programming in the Sub-Menu groups will backup the display to that Sub-Menu group heading. Pressing the MENU key while viewing the Sub-Menu groups will backup the display to the Top Level Menu.

#### **ACKNOWLEDGING ALARMS**

Most alarm messages are self-clearing. Press the ENTER key to acknowledge and clear alarms.

NOTE: Some keys and functions are password protected. Enter the password to gain access. The passwords are factory set as follows:

Operator = 0  
Supervisor = 2000

# General Operation

## 5.2 General Operation

The unit can display: Rate, Total, Grand Total, Temperature, Density, Presets and Time of Day. The Temperature and/or Density can be displayed even if you are using the Volumetric Flow Equation (a Temperature or Density sensor must be installed). The unit can perform Mass or Corrected Volume equations using a temperature or density sensor (these equations can be computed without Temp/Dens sensors by using user defined default values). The unit can be programmed to perform Ratemeter/Totalizer or Batching functions (see section 6.3, SELECT INSTRUMENT Submenu).

## 5.3 Ratemeter/Totalizer Operation

The Ratemeter/Totalizer mode is used primarily to monitor flowrate and accumulated total. The relays can be used to trigger flow, total, temperature or density alarms.

### 5.3.1 Password Protection for Rate/Total mode

After an Operator and/or Supervisor Password is entered in the setup mode (see section 6.3, SETUP PASSWORD submenu), the unit will be locked. The unit will prompt the user for the password when trying to perform the following functions:

- Clear Total
- Clear Grand Total
- Enter Menu
- Edit Preset 1
- Edit Preset 2

The Supervisor password should be reserved for supervisors. The Supervisor password will allow access to restricted areas of the Setup and Test menus.

### 5.3.2 Relay Operation in Rate/Total mode

Two relays are available for alarm outputs. The relays can be assigned to trip according to rate, total, temperature, density readings or general system alarms. The relays can be programmed for low or high alarms. Preset 1 (RLY1) and Preset 2 (RLY2) are easily accessible by pressing the PRESET 1 or PRESET 2 key on the front panel.

### 5.3.3 Pulse Output in Rate/Total mode

The isolated pulse output (open collector) is menu assignable to Volume Total, Corrected Volume Total or Mass Total. The pulse output duration can be set for 10mS (50 Hz max) or 100mS (5 Hz max). A pulse output scale factor (pulse value) can be set to scale the pulse output. The pulse output is ideal for connecting to remote totalizers or other devices such as a PLC. See section 1.3 for electrical specifications.

### 5.3.4 Analog Output in Rate/Total mode

The analog output is menu assignable to correspond to the Volume Rate, Corrected Volume Rate, Mass Rate, Temperature, Density, Volume Total, Corrected Volume Total or Mass Total. The analog output is ideal for "trend" tracking using strip chart recorders or other devices.

### 5.3.5 RS-232 Serial Port Operation in Rate/Total mode

The RS-232 serial port can be used for programming (using the Setup Disk) or for communicating to printers and computers in the Operating Mode (Run Mode).

### PC Communications:

The Setup Disk also allows the user to query the unit for operating status such as Flow Rate, Flow Total, Temperature, Density, Presets, etc.



## **Operation of RS-232 Serial Port with Printers:**

### Transaction Printing

For transaction printing, the user defines the items to be included in the printed document (see section 6.3.20 SET DATA OUTPUT, Select\_list). The transaction document can be initiated by pressing the PRINT key or by a remote contact closure.

### Data Logging

In data logging, the user defines the items to be included in each data log (see section 6.3.20 SET PRINTER OUTPUT, Select\_list). The user can also select when (time of day) or how often (print interval) the data log is to be made (see section 6.3.19 SET PRINTER OUTPUT, Configure).

### System Setup and Maintenance Report

The system setup and maintenance report lists all of the instrument setup parameters and usage for the current instrument configuration. The audit trail information and a status report is also printed. This report is initiated in the Test menu (see section 8.2.3 PRINT SYSTEM SETUP).

## **5.4 Batch Operation**

The Batch mode is used primarily to control batches. The main difference between the Batch mode and Rate/Total mode is the relay operation. The Batch mode allows the operator to "START" the unit via the front panel or remote input. Once started, the relays (RLY1 & RLY2) will energize and send power to a flow control device (i.e. solenoid valve or pump). The flow sensor will send a signal to the unit and total accumulation will begin. When the Prewarn value (PRESET 2) is reached, Relay 2 will drop out (this is ideal for flow slow down). When the Batch amount (PRESET 1) is reached, Relay 1 will drop out and the Batch is complete.

Several messages will be displayed during normal batch operation (i.e. Batch Fill, Batch Stopped). The keypad is disabled for the duration of these timed messages (approx. 2 sec).

### **5.4.1 Batch Configuration.**

When the unit is programmed for batch mode, several batch operation choices are available. These choices include: Up or Down Counting, Maximum Batch Preset, Batch Overrun Compensation, Auto Batch Restart, Time Delay, Flow Signal Timeout, Maximum Drain Time, Slow Start Quantity, Start or Reset/Start, and Stop or Stop/Reset.

### **Batch Count Mode**

The Batch Count Mode allows the user to choose whether the unit will batch up to a preset value or batch down from a preset value to zero.

### **Maximum Batch Preset**

The Maximum Batch Preset allows the user to program the Maximum Batch value allowed to be entered by the operator. If an operator should try to program a batch higher than this value, the unit will not allow the value to be entered and will prompt the user with an error message saying that the Maximum Batch Preset has been exceeded.

### **Batch Overrun**

The Batch Overrun is used for batch applications that have slow responding valves and a consistent batching flowrate. When the Batch Overrun is set, the unit will compensate for batch overruns by computing an averaged overrun value from the last four batches. This average is used to internally adjust the batch setpoint to minimize overrun.

### **Auto Batch Restart**

The Auto Batch Restart function allows the user to set an amount of time to automatically restart a batch after the completion of a batch (choose on or off).

## General Operation

### Time Delay

The Time Delay for Auto Batch Restart functions as follows: When a batch is completed, the next batch will automatically start after the amount of time entered here. This time can be set from 1 to 99 seconds.

### Flow Signal Timeout

The Flow Signal Timeout allows the user to enter a timeout of 0 to 99 seconds. If a batch is “Filling” and zero flow persists for more than the user entered time then the batch will be aborted. This prevents over flows due to faulty flow sensors and/or wiring.

### Maximum Drain Time

The unit declares that a batch is “done” when the flow rate equals “0”. A flow rate may be present long after the Preset Relay de-energizes due to slow reacting valves or leaky valves. The Maximum Drain Time allows the user to enter an amount of time (0 to 99 seconds) to wait before declaring “Batch Done”. After the Preset Batch quantity is reached, the unit will declare “Batch Done” when the flow rate is “0” or the Maximum Drain Time has expired. The batch data will then be available for printing and datalogging.

### Slow Start Quantity

The Slow Start Quantity is a function that allows an amount to be entered for a Slow Start up. This function requires two stage valve control. RLY 1 (slow flow) will energize for Slow Start and RLY 2 (fast flow) will energize after the Slow Start Quantity has been delivered. This helps reduce turbulence when filling an empty container.

### START, RESET/START and STOP, STOP/RESET

When configuring the control inputs, Control Input1 can be set for START or RESET/START. When set for START, the unit will start batching when a signal is applied to Control Input1 or the front panel Start key is pressed. A separate Reset signal must be used to clear the previous batch total. When set for RESET/START, the unit will automatically reset then start when a signal is applied to Control Input1 or the front panel Start key is pressed (provided that the previous batch was completed). If a previous batch was stopped during a batch cycle, the unit will Start from where it was stopped. Control Input 2 can be set for STOP or STOP/RESET. When set for STOP, the unit will stop batching when a signal is applied to Control Input 2 or the front panel Stop key is pressed. A separate Reset signal must be used to clear the batch total. When set for STOP/RESET, a running batch will stop when a signal is applied to Control Input 2 or the front panel Stop key is pressed. If the unit is Stopped or after a completed batch, the unit will reset when a signal is applied to Control Input 2 or the front panel Stop key is pressed. **NOTE:** Applying a voltage level to Control Input 2 will inhibit all Start inputs in either mode.

#### 5.4.2 Password Protection for Batcher Mode

After an Operator and/or Supervisor Password is entered in the setup mode (see section 6.3, SETUP PASS WORD submenu), the unit will be locked. The unit will prompt the user for the password when trying to perform the following functions:

- Clear Grand Total
- Enter Menu

The Supervisor password should be reserved for supervisors. The Supervisor password will allow access to restricted areas of the Setup and Test menus. The passwords are factory set as follows:

- Operator = 0
- Supervisor = 2000

#### 5.4.3 Relay Operation in Batcher mode

Two relays are available for alarm outputs. Preset 1 (RLY1) is reserved for batch amount, Preset 2 (RLY2) is reserved for prewarn. (see section 5.4 Batcher Operation for Relay 1 & Relay 2 functions) Preset 1 (RLY1) and Preset 2 (RLY2) are easily accessible by pressing the PRESET 1 or PRESET 2 key on the front panel.

#### **5.4.4 Pulse Output in Batch mode**

The isolated pulse output (open collector) is menu assignable to Volume Total, Corrected Volume Total or Mass Total. The pulse output duration can be set for 10mS (50 Hz max) or 100mS (5 Hz max). A pulse output scale factor (pulse value) can be set to scale the pulse output. The pulse output is ideal for connecting to remote totalizers or other devices such as a PLC. See section 1.3 for electrical specifications.

#### **5.4.5 Analog Output in Batch mode**

The analog output is menu assignable to correspond to the Volume Rate, Corrected Volume Rate, Mass Rate, Temperature, Density, Volume Total, Corrected Volume Total or Mass Total. The analog output is ideal for "trend" tracking using strip chart recorders or other devices.

#### **5.4.6 RS-232 Serial Port Operation in Batch mode**

The RS-232 serial port can be used for programming (using the Setup Disk) or for communicating to printers and computers in the Operating Mode (Run Mode).

#### **PC Communications:**

The Setup Disk also allows the user to query the unit for operating status such as Flow Rate, Flow Total, Temperature, Density, Presets, etc.

#### **Operation of RS-232 Serial Port with Printers:**

##### Transaction Printing

For transaction printing, the user defines the items to be included in the printed document (see section 6.3.20 SET DATA OUTPUT, Select\_list). The transaction document can be initiated by pressing the PRINT key, by a remote contact closure or print at end of batch.

##### Data Logging

In data logging, the user defines the items to be included in each data log (see section 6.3.20 SET PRINTER OUTPUT, Select\_list). The user can also select when (time of day) or how often (print interval) the data log is to be made (see section 6.3.19 SET PRINTER OUTPUT, Configure).

##### System Setup and Maintenance Report

The system setup and maintenance report lists all of the instrument setup parameters and usage for the current instrument configuration. The audit trail information and a status report is also printed. This report is initiated in the Test menu (see section 8.2.3 PRINT SYSTEM SETUP).

# General Operations

## 6. PROGRAMMING

### 6.1 Front Panel Operation Concept for Program Mode

The 121 Series may be fully programmable through the front panel. Please review the following usage summary before attempting to use the instrument.

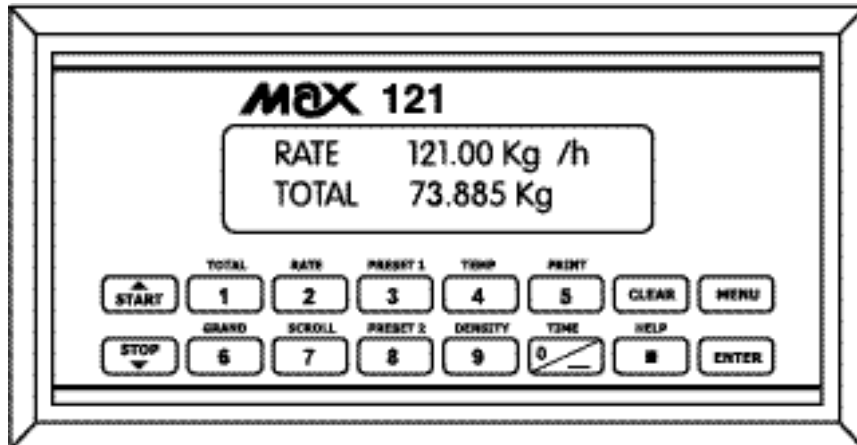

#### Setup Mode:

#### MODE CHANGES

Pressing the MENU key will offer selections of RUN, SETUP, TEST. RUN is the normal operating mode for the instrument. SETUP offers various sub-menus used for instrument setup. TEST offers various sub-menus for Test, Calibration and System Start-up.

#### Submenu GROUP NAVIGATION

Use the UP and DOWN arrow keys to navigate up and down through the Sub-Menu groups when in the SETUP or TEST mode. Press the ENTER key to enter a desired setup or test Sub-Menu group.

#### SELECTION OF ITEM

During setup, the unit will often offer multiple choices for a given topic. The topic prompt appears on the top line of the display. The choices are shown on the lower line of the display.

**To select an item, press the key beneath the desired choice. The selected choice will blink. Press the ENTER key to accept the selected choice.**

#### NUMERIC ENTRY

The keys labeled "0 - 9", "-", ".", CLEAR and ENTER are used to enter numerical values. **A leading 0 will assume that you intend to enter a minus "-" sign.** Press the CLEAR key to clear the existing value and to enable editing.

#### TEXT CHARACTER ENTRY

Some setup items (i.e. Descriptors, Units Label) require the user to enter text characters. Press CLEAR to enable editing. The UP and DOWN arrow keys are used to scroll through the available character sets for each individual character. Press the ENTER key to accept the character and advance to the next character.

## 6.2 EZ Setup

The EZ Setup routine is a quick and easy way to configure the unit for the most commonly used instrument functions. This setup assumes that you are measuring Volumetric Flow. Entering the EZ Setup mode automatically sets many features. This may cause any previously programmed information to be lost or reset. For a complete customized configuration, see sections 6.3 and 6.4.

### 6.2.1 TOP LEVEL SETUP MENU

SELECT OPERATE STATE  
Run Setup Test

Select Setup to enter the instrument setup routine.



### 6.2.2 EZ Setup Submenu Groups

SELECT EZ SETUP

Press ENTER to begin EZ Setup routine.

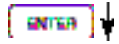

ARE YOU SURE?  
No Yes

Confirm that you want to run EZ Setup. Caution: Any previous program settings may be lost or reset.



INSTRUMENT TYPE  
Rate/Tot Batch

Instrument Type.

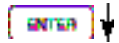

RATE time base  
Sec Min Hour Day

Select the appropriate rate time base.

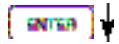

RATE Dec places  
0

Enter the desired rate decimal location. 0-3 decimal places allowed.



TOTAL VOLUME UNITS  
gal

Enter the desired totalizer units label.



TOTAL Dec places  
0

Enter the desired totalizer decimal location. 0-3 decimal places allowed.

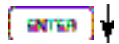

K\_FACTOR TYPE  
Avg LinTbl UVC

Enter the desired K-Factor Type.



AVERAGE KA-FACTOR  
##### P/gal

If Average selected, Enter the desired Average K-Factor.

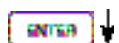

LINEAR TABLE KA  
Fre01:##### Hz

If LinTbl or UVC selected, Enter the desired frequency/ K-Factor pair for each point in the Linearization Table. (up to 16 pairs) Enter a frequency of 0 for any point other than Fre01 to exit Linearization Table setup.



LINEAR TABLE KA  
KA--01:#####

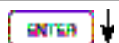

FS ANALOG OUT 20mA  
#####gal/m

Enter the desired full scale setting for the analog output.

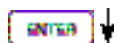

RATE 00.0 gal/m  
TOTAL 0 gal

Return to Run Mode

TOP LEVEL  
SETUP MENU

6.3.2  
EZ Setup  
Submenu  
Groups

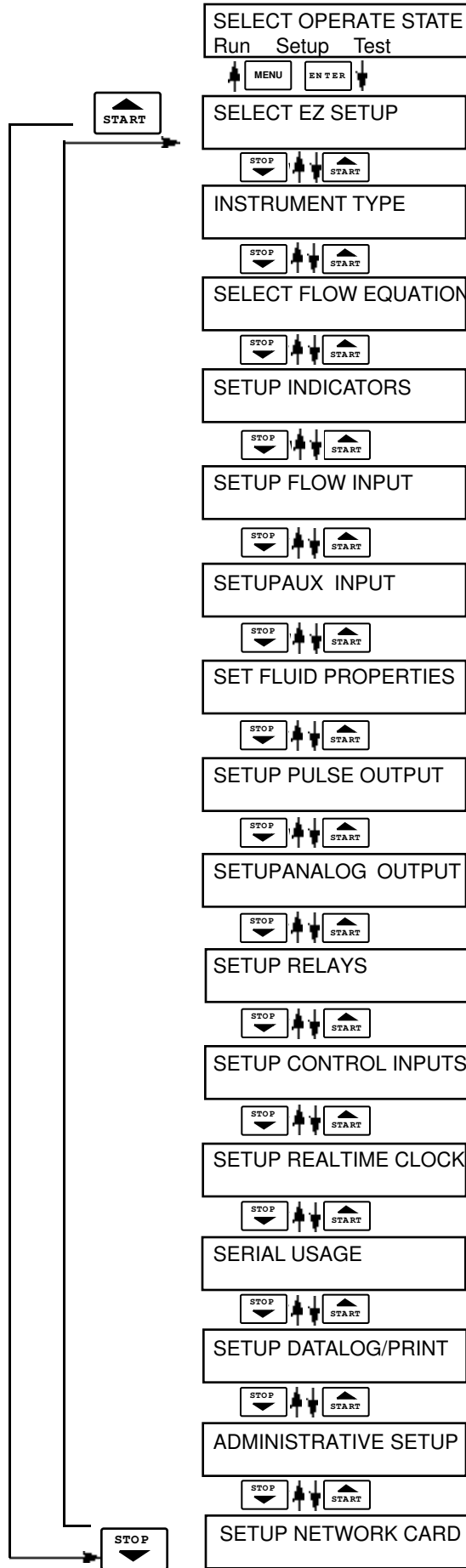

Select Setup to enter the instrument setup routine.

Refer to Page 21 for Details.

Refer to Page 23 for Details.

Refer to Pages 24 for Details.

Refer to Page 24 & 25 for Details.

Refer to Page 26, 27 & 28 for Details.

Refer to Pages 29 for Details.

Refer to Page 30 for Details.

Refer to Pages 30 for Details.

Refer to Page 31 for Details.

Refer to Page 31 & 32 for Details.

Refer to Page 33 for Details.

Refer to Page 34 for Details.

Refer to Page 35 for Details.

Refer to Pages 36 & 37 for Details.

Refer to Page 37 for Details.

Refer to Page 38 for Details.

6.4.1  
SELECT EZ  
SETUP

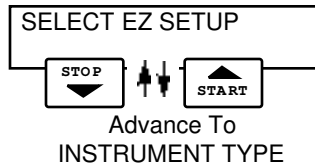

Refer to page 21 for EZ Setup routine.  
Press the DOWN (stop) key to advance to Instrument Type. Press the UP (start) key to advance to Administrative Setup.

6.4.2  
INSTRUMENT  
TYPE



Press ENTER to enter Instrument Type sub-menus.

Rate/Tot

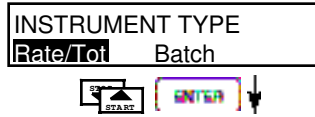

Press ENTER when Rate/Total is flashing to configure the instrument as a Ratemeter/Totalizer.

Advance To  
SELECT FLOW EQUATION

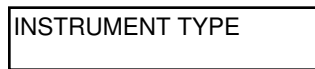

If Rate/Tot selected, advance to Select Flow Equation.

Press ENTER to enter Instrument Type sub-menus.

Batch

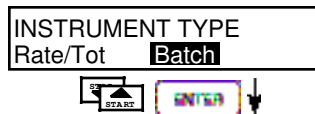

Press ENTER when Batch is flashing to configure the instrument as a Batcher.



Select UP to Reset to 0 and count up to preset. Select DOWN to reset to Preset and count down to 0.

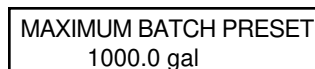

Enter the maximum allowable Batch Preset. The operator will not be able to enter a batch preset larger than this value.



Select ON to set the unit to operate using a Batch Overrun Compensation routine. Select OFF to inhibit Batch Overrun Compensation routine. (See Section 5.4)



Select On to enable the Auto Batch Restart. This will automatically restart the unit at the end of each batch run. Select Off if this is not desirable.

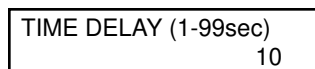

Enter Time Delay for Auto Batch Restart. When a batch is completed, the next batch will start after the amount of time entered here.

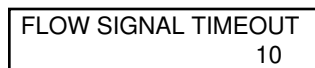

Enter a timeout of 0 to 99 seconds. If a batch is "Filling" and zero flow persists for more than this time, the batch will be aborted.

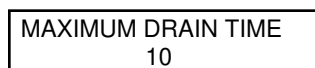

Enter time (0-99 sec.) for Max. Drain Time. After batch quantity is reached, "Batch Done" is declared when the flow rate is "0" or the Maximum Drain Time has expired.

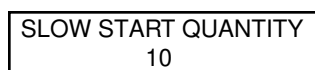

Enter a quantity for a Slow Start up. RLY 2 (slow flow) will energize for Slow Start and RLY 1 (fast flow) will energize after the Slow Start Quantity has been delivered.

Advance To  
SELECT FLOW EQUATION

6.4.3  
SELECT  
FLOW EQUATION

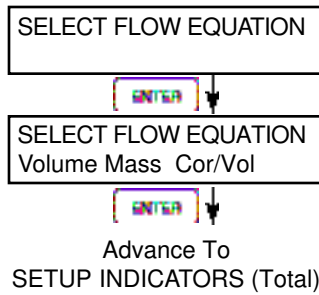

Press ENTER to enter Select Flow Equation sub-menus.

Press ENTER when desired flow equation is flashing.

6.4.4  
SETUP  
INDICATORS  
(Total)

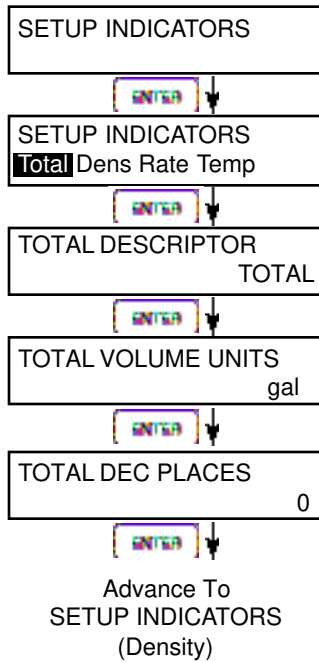

Press ENTER to begin setup of the Indicators

Press ENTER when Total is flashing to configure the Totalizer Indicators

Enter the desired Total Descriptor

Enter the desired Volume Units Label for the Totalizer.

Select the desired Total Decimal Place. 0-3 decimal places allowed.

6.4.5  
SETUP  
INDICATORS  
(Density)

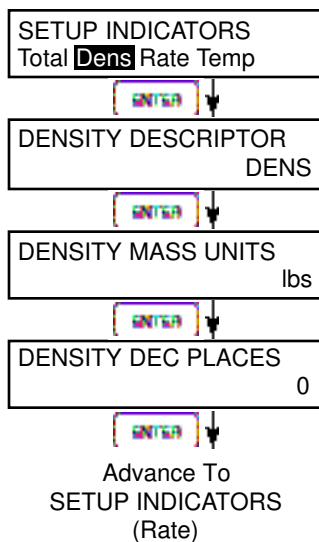

Press ENTER when Dens is flashing to configure the Density Indicators.

Enter the desired Density Descriptor.

Enter the desired Mass Units Label for Density.

Select the desired Density Decimal Place. 0-6 decimal places allowed.



6.4.6  
 SETUP  
 INDICATORS  
 (Rate)

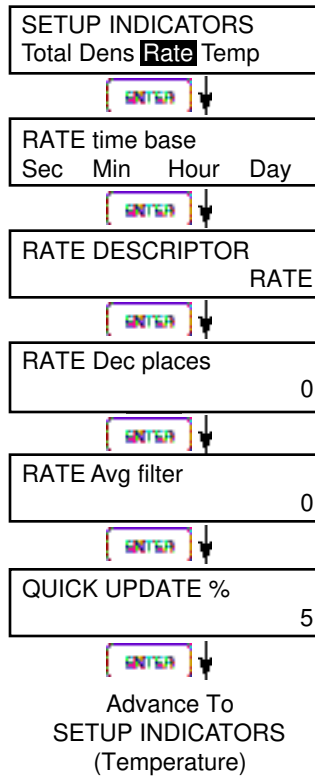

Press ENTER when Rate is flashing to configure the Ratemeter Indicators

Select the desired Rate Time Base.

Enter the desired Descriptor for the Ratemeter.

Select the desired Rate Decimal Place.  
 0-3 decimal places allowed.

Enter desired Rate Averaging Filter.

Enter desired Percent of Change for Quick Update. If the current flowrate deviates by an amount greater than the percentage value entered, the Rate Averaging is inhibited. (See Page 62 for more details.)

6.4.7  
 SETUP  
 INDICATORS  
 (Temperature)

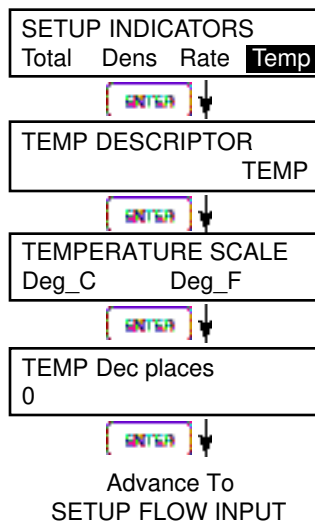

Press ENTER when Temp is flashing to configure the Temperature Indicators.

Enter the desired Temperature Descriptor.

Enter the desired Temperature Scale.

Select the desired Temperature Decimal Place.  
 0-3 decimal places allowed.

**6.4.8  
SETUP  
FLOW INPUT**

(Pulse - Ain & PS  
(A=B))

NOTE:  
Ain = Single Pulse  
PS(A=B) = Pulse  
Security  
Qx1 = Quadrature  
Qx2 = Quadrature x 2

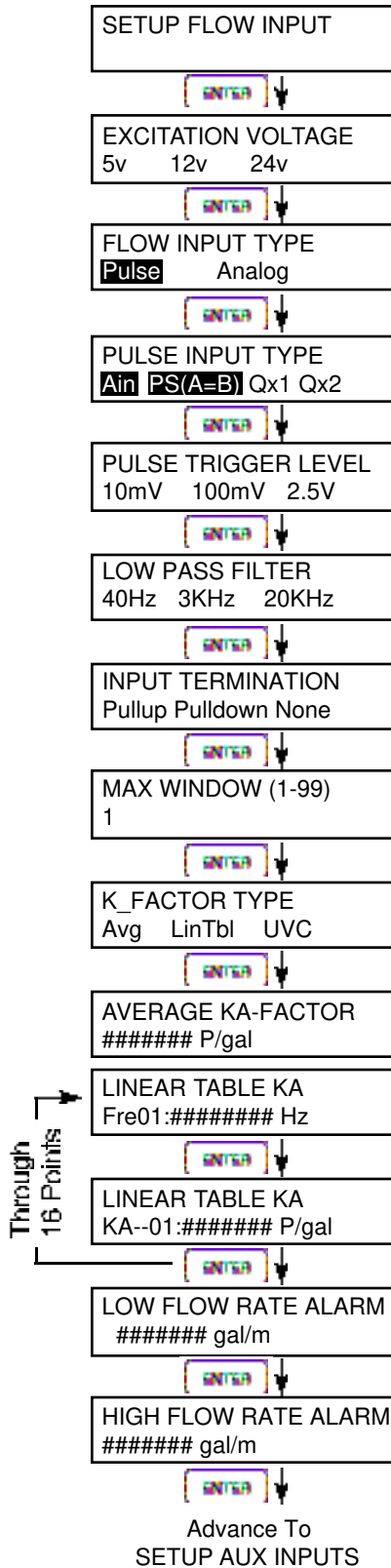

Press ENTER to begin setup of Flow Input.

Select the desired Excitation Voltage.

Press ENTER when Pulse is flashing to configure the flow input for Pulse signals.

Enter the desired Pulse type. See side note.

Select the desired Input Pulse Trigger Level.

Select the desired Low Pass Filter.  
(Max. Count Speed).

Select the proper input termination.

Enter the desired Maximum Sample Window Time  
(1-99 sec).

Enter the desired K-Factor Type.

If Avg selected, Enter the desired Average K-Factor.

If LinTbl selected,  
Enter the desired frequency/ K-Factor pair for each  
point in the Linearization Table.

**NOTE:** Enter 0 for Fre value of any point (other than  
Fre01) to exit the routine and use the values  
entered up to that point.

Enter the desired volumetric Low Rate Alarm.  
This will trigger an alarm message if alarm condi-  
tions occur. The relays are not affected.

Enter the desired volumetric High Rate Alarm.  
This will trigger an alarm message if alarm condi-  
tions occur. The relays are not affected.

**SETUP**

**FLOW INPUT**

(Pulse - Quadrature, Qx1 or Qx2)

**NOTE:**

Ain = Single Pulse  
 PS(A=B) = Pulse Security  
 Qx1 = Quadrature  
 Qx2 = Quadrature x 2

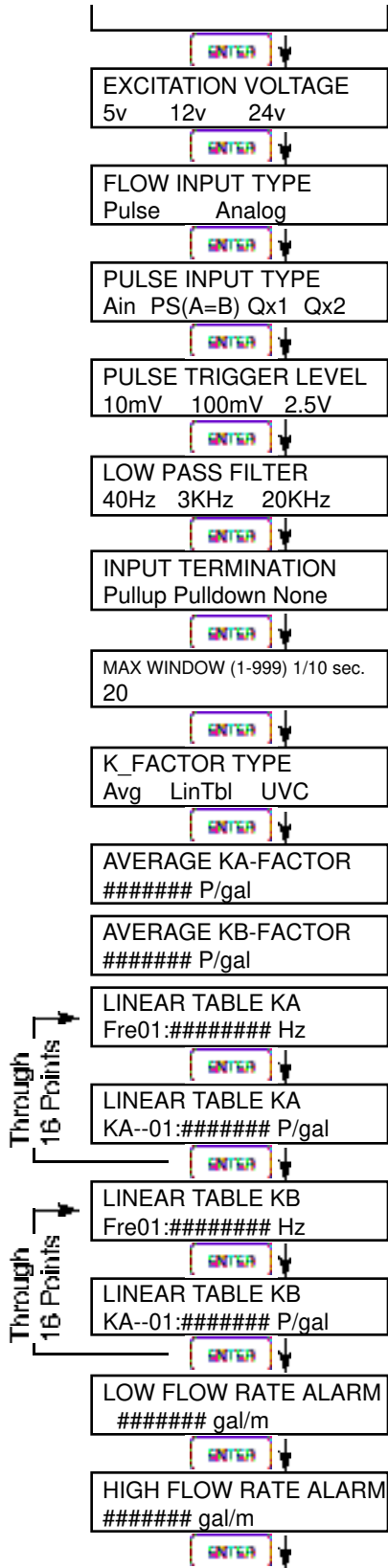

Advance To  
 SETUP AUX INPUTS

Select the desired Excitation Voltage.

Press ENTER when Pulse is flashing to configure the flow input for Pulse signals.

Enter the desired Pulse type. See side note.

Select the desired Input Pulse Trigger Level.

Select the desired Low Pass Filter.  
 (Max. Count Speed).

Select the proper input termination.

Enter the desired Maximum Sample Window Time (1-999 in 1/10 sec increments).

Enter the desired K-Factor Type.

If Avg selected, Enter the desired Average K-Factor (KA for channel A).

Enter the desired Average K-Factor (KB for channel B).

If LinTbl selected, Enter the desired frequency/ K-Factor pair for each point in the Linearization Table. (channel A)

**NOTE:** Enter 0 for Fre value of any point (other than Fre01) to exit the routine and use the values entered up to that point.

Enter the desired frequency/ K-Factor pair for each point in the Linearization Table. (channel B)

**NOTE:** Enter 0 for Fre value of any point (other than Fre01) to exit the routine and use the values entered up to that point.

Enter the desired volumetric Low Rate Alarm. This will trigger an alarm message if alarm conditions occur. The relays are not affected.

Enter the desired volumetric High Rate Alarm. This will trigger an alarm message if alarm conditions occur. The relays are not affected.

**6.4.10  
 SETUP  
 FLOW INPUT  
 (Analog)**

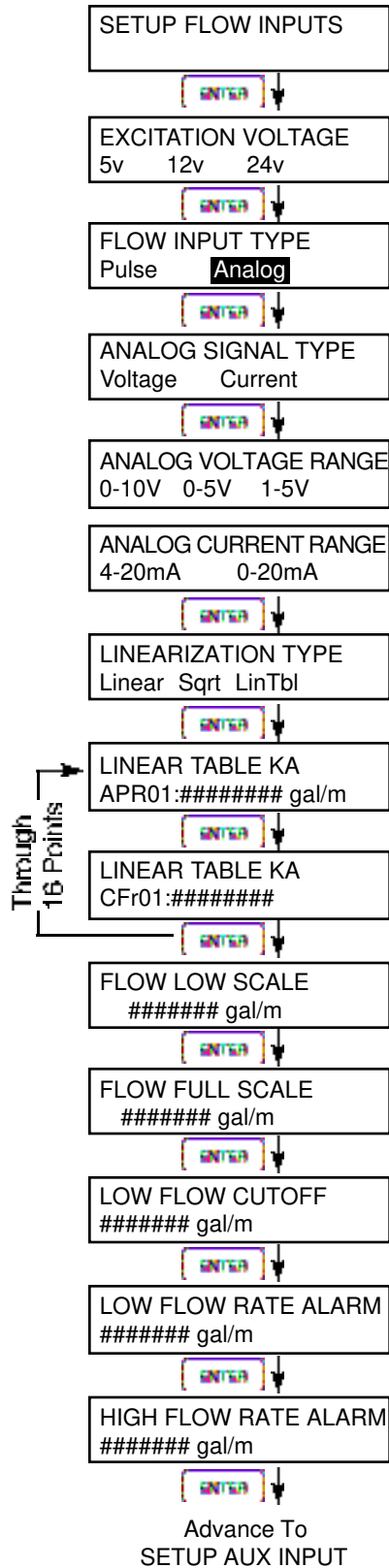

Press ENTER to begin setup of the Flow Input.

Select the desired Excitation Voltage.

Press ENTER when Analog is flashing to configure the flow input for Analog signals .

Choose Analog Signal Type.

If Voltage selected,  
 Choose desired Voltage Range.

If Current selected,  
 Choose desired Current Range.

Select the desired Linearization Type.

If LinTbl selected,  
 Enter the desired Apparent Input Flow (APR) / Correction Factor (Cfr) pair for each point in the Linearization Table.

**NOTE:** Enter 0 for APR value of any point (other than APR01) to exit the routine and use the values entered up to that point.

Enter the low flowrate corresponding to the low analog signal. (typically zero)

Enter the High flowrate corresponding to the High analog signal.

Enter the desired Low Flow Cutoff.

Enter the desired volumetric Low Rate Alarm. This will trigger an alarm message if alarm conditions occur. The relays are not affected.

Enter the desired volumetric High Rate Alarm. This will trigger an alarm message if alarm conditions occur. The relays are not affected.

### 6.4.11 SETUPAUX INPUT

**NOTE:**  
When Density (Dens) is selected, The menu prompts will be very similar to the Temperature prompts. The menus will prompt the user for density values and density units.

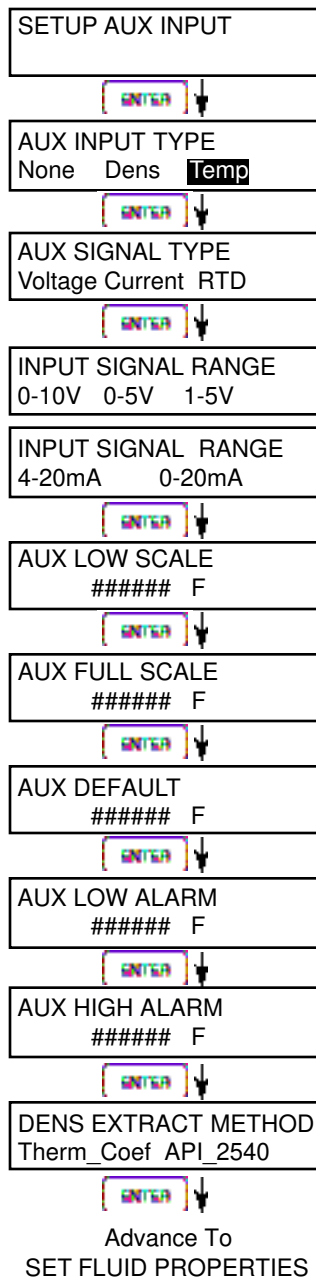

Press ENTER to begin setup of the Auxiliary Input.

Select Temperature to set the Auxiliary Input for Temperature inputs.

Choose Temperature Signal Type. Advance to "Aux Default", if RTD selected.

If Voltage selected, Choose desired Voltage Range. Skip if RTD.

If Current selected, Choose desired Current Range. Skip if RTD.

Enter the low temperature scale corresponding to the low temperature signal. Skip if RTD.

Enter the high temperature scale corresponding to the high temperature signal. Skip if RTD.

Enter the Default Temperature. The unit will use this value if the temperature input fails.

Enter the Low setpoint for the Temperature Alarm.

Enter the High setpoint for the Temperature Alarm.

Choose the Density Extraction method to be used. (API\_2540 Equation not recommended)

**6.4.12  
SET FLUID  
PROPERTIES**

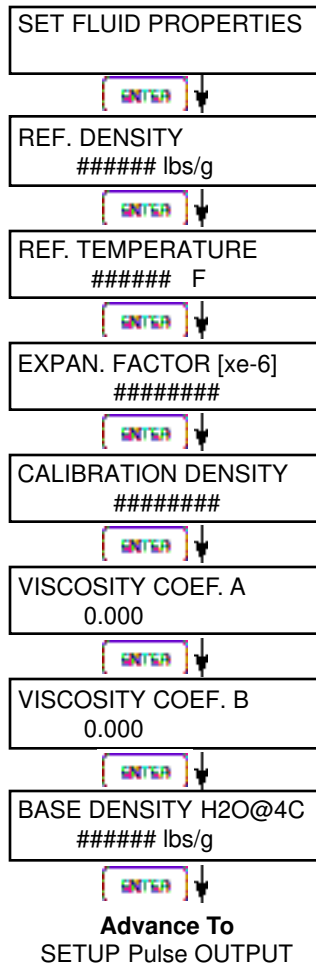

Press ENTER at this prompt to Set Fluid Properties.

Enter the Reference Density. This is used in the calculation of density when you have a temp transmitter and used for corrected flow calculation if you have a density transmitter.

Enter the Reference Temperature.

Enter the proper Expansion Factor.  
(If Temp Compensated for Mass or Corrected Volume)  
See Section 7.4, Calculating the Expansion Factor.

Enter the Calibration Density. This is used in calculation of flow for analog inputs using SQRT.

Not applicable for P.0 meters

Not applicable for P.0 meters

Enter the Base Density H2O@4C. This is used in the centistoke calculation for UVC.

**6.4.13  
SETUP  
PULSE OUTPUT**

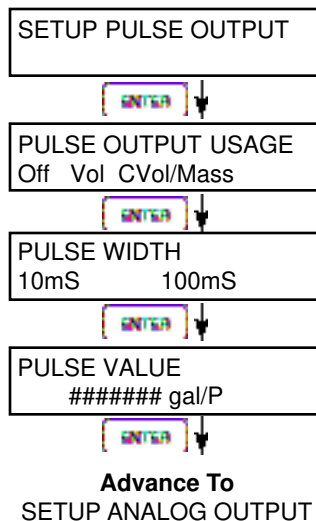

Press ENTER at this prompt to setup the Pulse Output.

Select the desired Pulse Output Usage.

Select the desired Pulse Width for the Pulse Output.

Enter the desired Pulse Value for the Pulse Output (Units per Pulse).

**6.4.14  
SETUP  
ANALOG OUTPUT**

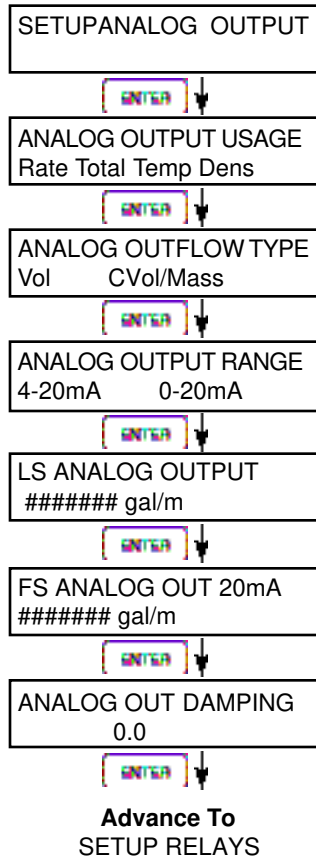

Press ENTER when Analog is flashing to setup the Analog Output.

Select the desired Analog Output Usage.

Only if Rate selected & Flow EQ. = Mass, Cor/Vol  
Select the desired Analog Output Flow.

Select the desired current range for the Analog Output.

Enter desired Analog Output Low Scale Value.  
**NOTE:** Units label will correspond with output usage type selected.

Enter desired Analog Output Full Scale Value.

Enter the desired Analog Output Damping Constant.

**6.4.15  
SETUP RELAYS  
(Relay 1 & Relay 2)**

**NOTE:**  
In Batch mode, Relay 1 is reserved for Preset, Relay 2 is reserved for Prewarn.

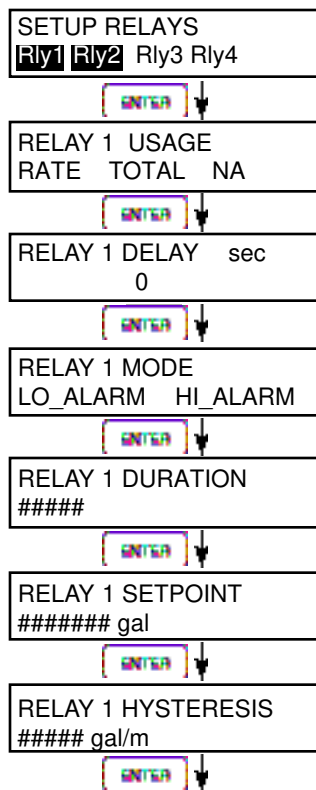

Select the desired Relay for setup.  
(Relays 3 & 4 Optional)

If Relay 1 or Relay 2 Selected,  
Select Rate, Total or NA.

If Rate selected, enter desired relay activation delay value.

Select the desired Relay Activation.  
Low: Relay activates when reading is below setpoint.  
High: Relay activates when reading is above setpoint.

If Total Selected, Enter desired Relay Duration.

Enter the desired Setpoint. The Setpoint can be edited in run mode using the PRE 1 key (PRE 2 key for Relay 2).

If Rate, selected, Enter desired Relay Hysteresis.

## RELAY NOTES & CONSIDERATIONS

1. Relay activation is based on the computed readings not the displayed value. Therefore the display damping factor will not affect the relay response time. The RELAY DELAY feature allows the user to enter a time delay for relay activation. This feature is very useful in applications where short over/under range conditions are not considered alarm conditions.
2. When INSTRUMENT TYPE is set to batcher, Relay 1 is reserved for PRESET and Relay 2 is reserved for PREWARN. (the Prewarn value is relative to the Preset value. Input the number of units that Relay 2 should “drop out” in advance of Relay 1.)
3. Setting the relays to NA (Not Assigned), will allow the relay activation to be controlled via the RS-232 Serial ports.



**6.4.16**  
**SETUP CONTROL**  
**INPUTS**  
 (RATE/TOTAL)

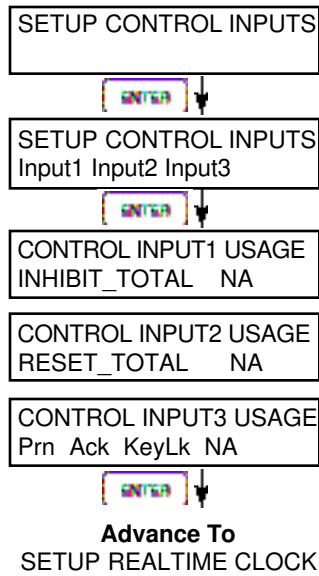

Press Enter to begin setup of the Control Inputs.

Select the desired Control Input for setup.

If Control Input 1 Selected,  
 Select Inhibit Total or NA (Not Assigned).

If Control Input 2 Selected,  
 Select Reset Total or NA (Not Assigned).

If Control Input 3 Selected,  
 Select Prn (Print), Ack (acknowledge), KeyLk (Keylock)  
 or NA (Not Assigned). ACK will acknowledge and clear  
 alarms and warning messages.

**Note:** Alarms may reassert themselves if alarm condi-  
 tions are still present.

**6.4.17**  
**SETUP CONTROL**  
**INPUTS**  
 (BATCH)

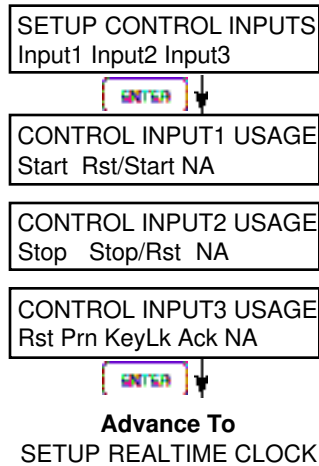

Select the desired Control Input for setup.

If Control Input 1 Selected,  
 Select Start ,Reset/Start, NA (Not Assigned).

If Control Input 2 Selected,  
 Select Stop, Stop/Reset, NA (Not Assigned).

If Control Input 3 Selected,  
 Select Prn (Print), Ack (acknowledge), KeyLk (Keylock)  
 or NA (Not Assigned). ACK will acknowledge and clear  
 alarms and warning messages.

**Note:** Alarms may reassert themselves if alarm condi-  
 tions are still present.

**6.4.18  
SETUP REAL-  
TIME CLOCK  
(Time)**

SETUP REALTIME CLOCK



SETUP REALTIME CLOCK  
Time Date

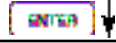

CLOCK TYPE  
24HR 12HR



SELECT CLOCK AM/PM  
AM PM



TIME OF DAY HH:MM:SS  
##:##:##



**Advance To**  
SETUP REALTIME CLOCK  
(Date)

Press Enter to begin setup of the Realtime Clock.

Select Time to set the time.

Select 24Hr or 12Hr clock

If 12Hr Clock,  
Enter AM or PM

Enter time of day.

**6.4.19  
SETUP REAL-  
TIME CLOCK  
(Date)**

SETUP REALTIME CLOCK  
Time Date

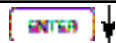

DATE: MONTH,DAY,YEAR  
##/##/####



**Advance To**  
SERIAL USAGE

Select Date to enter the date.

Enter the date. (Month, Day, Last two digits of Year)

**6.4.20  
SERIAL USAGE**

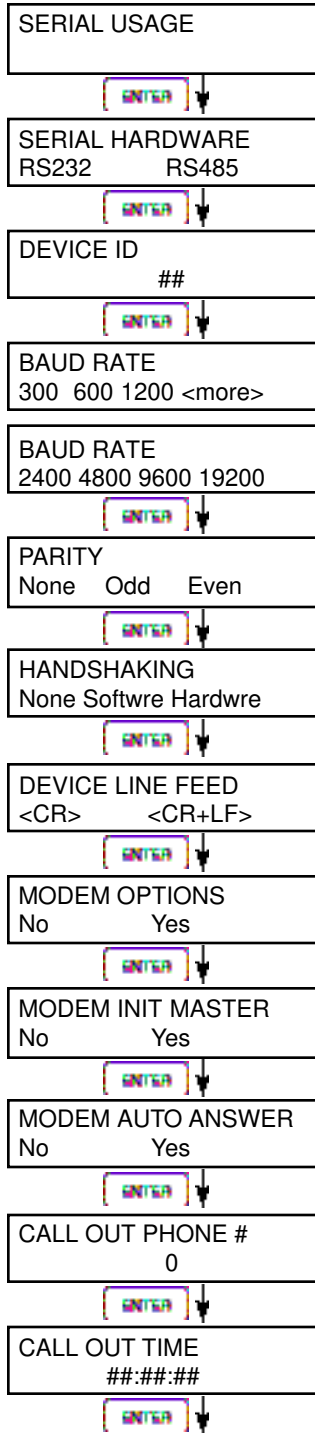

Press Enter to begin setup of the Serial Port.

Select Serial Hardware type for standard port.

Select the Device ID.

Select the desired Baud Rate.

(If <more> selected)

Select the desired Parity.

Set the Handshake.

Choose end of line termination. Only choose <CR> if your external device automatically assigns a line feed for every <CR> carriage return.

Select "Yes" if the serial port will be used to control a modem.

Select "Yes" to have the unit engage in a configuration conversation with the modem on power up .

Select the desired Modem Auto Answer mode.

Enter the Call Out Phone Number to be dialed for "Call Out Time" or "Print On Error/Alarm".

Enter the time of day to perform Call Out transmission.

**Continued on Next Page**

**6.4.20**  
**SERIAL USAGE**  
 (continued)

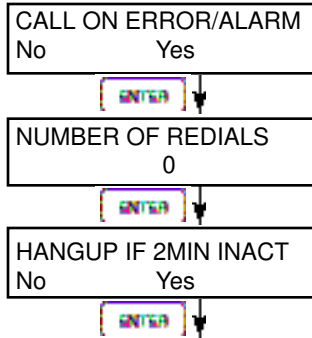

Select "Yes" to have the unit perform a Call Out transmission upon error/alarm condition.

Enter the number of redials to be performed on call out time if busy or no answer. (error/alarm tries until connected)

Select "Yes" to perform hangup if there is inactivity for more than 2 minutes.

Advance To  
 SETUP DATALOG/PRINT

**6.4.21**  
**SETUP**  
**DATALOG/PRINT**  
 (Configure)

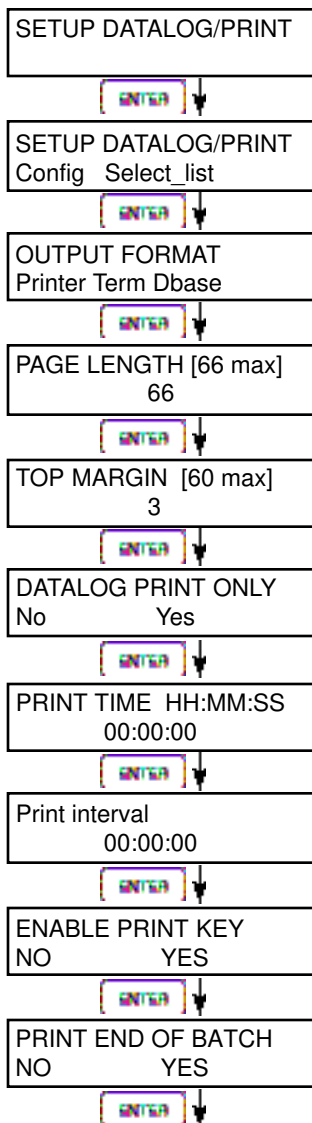

Press Enter to setup the Datalog/Print information.

Select Config to configure the Datalog/Print information.

Select the type of Output Format.

Enter the desired Page Length.  
 If Printer selected above.

Enter the desired Top Margin.  
 If Printer selected above.

Select Yes to record events to the datalogger only.  
 Events will not be sent to the serial port.

Enter Print Time, printer will print at this time every day.  
 Enter 00:00:00 to inhibit print time.

Enter Print Interval,  
 Enter 00:00:00 to inhibit print interval..

Select YES to enable Print Key.  
 Select NO to disable Print Key

Batch mode only.  
 Select Yes to print at end of batch.

Advance To  
 SETUP DATALOG/PRINT  
 (Select\_list)

**6.4.22  
SETUP  
DATALOG/PRINT  
(Select\_list)**

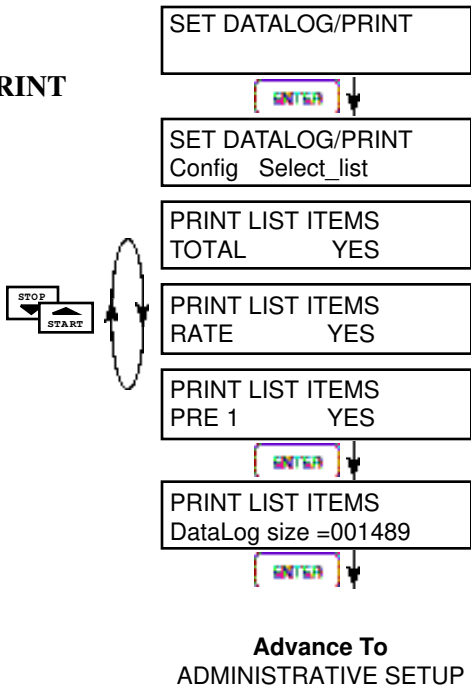

**List Items:**

- Total
- Rate
- Pre1
- temp
- grand
- pre2
- dens
- time

Press enter to begin Setup Datalog/Print routine.

Press enter when Select\_list is selected to setup print list.

Use Up and Down arrow keys to view list status. Press the Corresponding function key to the items that you wish to add or remove from the list.

Items marked with Yes will be added to the list, items marked with No will be removed from the list.

The Select Print List Information display shows the current possible Datalog size.

**6.4.23  
ADMINISTRATIVE  
SETUP**

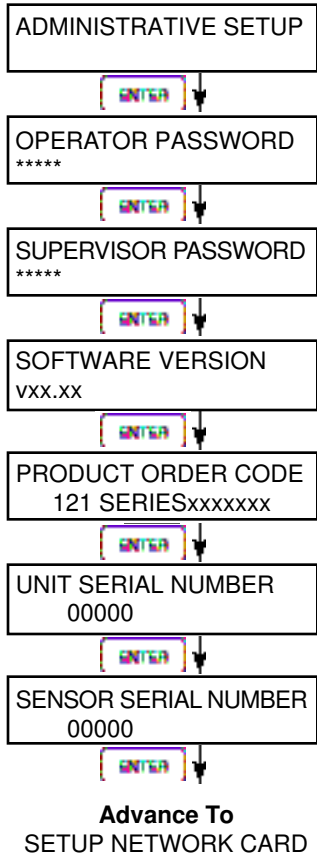

Press Enter to begin Administrative Setup.

Enter Operator Password. (Factory Set to 0)

Enter Supervisor Password. (Factory Set to 2000)

This display is used to show the software version of the installed software.

This display is used to show the product order code (model number).

This display is used to show the unit's serial number.

This display is used to show the sensor's serial number.

**6.4.24  
SETUP  
NETWORK CARD  
(optional)**

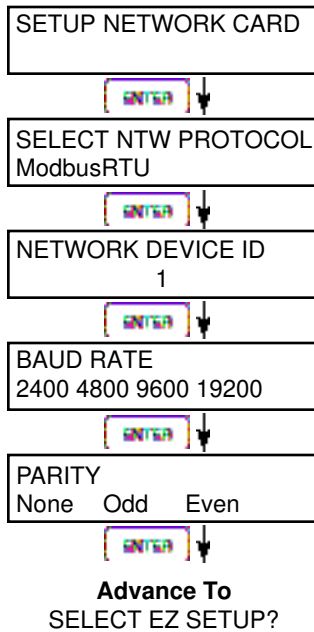

Press Enter to setup Network Card

Select desired Network Protocol.

Enter the device address on network (00-255).

Select the desired Baud Rate.

Select the desired Parity.

## 7.1 General:

### General Operation

The 121 Series Flow Computer uses several internal calculations to compute the compensated flow based on specific data input. Several computations are performed to arrive at the uncompensated flow, temperature, density and viscosity. This information is then used to compute the Corrected Volume Flow or Mass Flow.

## 7.3 Flow Equations:

### Input Flow Computation:

#### Linear or External SQRT

Input Flow = [% input span • (flow FS - flow low scale)] + flow low scale

### Input Flow Computation:

#### General Case

Tf = [% input span • (temp FS - Temp low scale)] + temp low scale

#### RTD Case

Tf = f(measured input resistance)

### Input Density Computation:

#### Temperature Transmitter

density = reference density • (1 - Therm.Exp.Coef. • (Tf-Tref))<sup>2</sup>

#### Density Transmitter

density = [% input span • (density FS - density low scale)] + density low scale

### Uncompensated Flow Computation:

#### Pulse Input; Average K-Factor

Volume Flow =  $\frac{\text{input frequency} \cdot \text{time scale factor}}{\text{K-Factor}}$

#### Pulse Input; Linear Table

Volume Flow =  $\frac{\text{input frequency} \cdot \text{time scale factor}}{\text{K-Factor (Hz)}}$

#### Analog Input; Linear

Volume Flow = input flow

#### Analog Input; Linear Table

Volume Flow = input flow • correction factor (input flow)

**Corrected Volume Flow Computation:**

Temperature Transmitter

$$\text{Standard Volume Flow} = \text{volume flow} \cdot (1 - \text{Therm.Exp.Coef.} \cdot (T_f - T_{ref}))^2$$

Density Transmitter

$$\text{Standard Volume Flow} = \text{volume flow} \cdot \frac{\text{density}}{\text{reference density}}$$

**Mass Flow Computation:**

$$\text{Mass Flow} = \text{volume flow} \cdot \text{density}$$



## 7.4 Calculating the Expansion Factor

### Calculating Expansion Factor

Two temperature-specific gravity pairs will be required to compute the temperature coefficient.

The reference temperature is simply chosen by the user. Common reference temperatures are 60 F or 15 C.

The reference temperature should be chosen so that it is in the application temperature range. (ex. application temperature range -10 to 120 F, reference temperature of 60 F chosen.)

Enter the reference temperature you have chosen at this point.

The reference specific gravity corresponds to the fluid SPECIFIC GRAVITY at the reference temperature chosen.

You may convert the fluid density information to specific gravity if it is in units other than specific gravity. Use EQ1.

CAUTION: Since the expansion factor is based on a per degree change in temperature, the temperatures used in the following equations must match (Fahrenheit or Centigrade) the units used on the indicator display programming.

### Expansion Factor Equations

EQ1.

$$\text{Spec.Grav.} = \text{Density of Fluid} / \text{Density of Water}$$

Given the reference temperature, reference specific gravity, a second temp. and a second Spec.Grav., the Expansion Factor (C Factor) can be computed as follows:

EQ2. Used for Liquid Mass and Corrected Volume Equations

$$C = \frac{1 - \sqrt{(\text{Spec.Grav.2} / \text{Ref.Spec.Grav.})}}{\text{Temp.2} - \text{Ref.Temp}} \times 1,000,000$$

Given the reference temperature, reference density, a second temp. and a second density, the Expansion Factor (C Factor) can be computed as follows:

Example: Diesel fuel (0.845@20°C, 0.830@42°)

$$C = \frac{1 - \sqrt{0.83/0.845}}{(42-20)} \times 1,000,000 = 405.25$$

EQ3. Used for Liquid Mass and Corrected Volume Equations

$$C = \frac{1 - \sqrt{(\text{Dens.2} / \text{Ref.Dens.})}}{\text{Temp.2} - \text{Ref.Temp}} \times 1,000,000$$

## 7.6 Linearization Table

### 7.6.1 Linearization Table General Information

The Linearization Table is used when the flow input device gives a nonlinear input signal. The unit uses up to 16 different points, as entered by the operator, to form a curve for linearizing the input signal.

Notes:

- 1) A minimum of three points must be set up.
- 2) If "0" is entered for the frequency of any point other than point 1, the Flow Computer assumes there are no more points above the points that preceded them. The display will advance to the next setup prompt. Extrapolation is taken from the last two nonzero points.
- 3) If the input frequency is above the highest or below the lowest frequency programmed, the unit will use the last known point for the K factor in computing the resulting actual flow.
- 4) Frequencies or apparent flows should be entered in **ascending order**.

### 7.6.2 Linearization Table for Pulse Inputs

The linearization table for pulse inputs programming is quite simple when values of frequency and flow are known. The Flow Computer asks for 16 different frequencies (Freq) and 16 corresponding K factors (K). It then uses this data to determine what the actual flow is for any given input frequency. Usually the necessary data is provided with the flowmeter.

### 7.6.3 Linearization Table for Analog Inputs

The Linearization Table for Analog inputs programming is similar to the Pulse input setup. The Flow Computer asks for 16 different flow rates (apparent flow) and 16 corresponding Correction Factors. It then uses this data to determine what the Actual flow is for any given apparent input signal. Again, a minimum of three points must be set up.

$$\text{Correction factor} = \frac{\text{Actual Flow}}{\text{Apparent Input Flow}}$$

The same rules that applied for the Digital setup apply for the Analog setup as well.

The Flow Computer prompts you for the Apparent input signal (APR) and a correction factor (CFr) to multiply it by to yield true actual flow.

8.1.1  
TOP LEVEL  
TEST MENUS

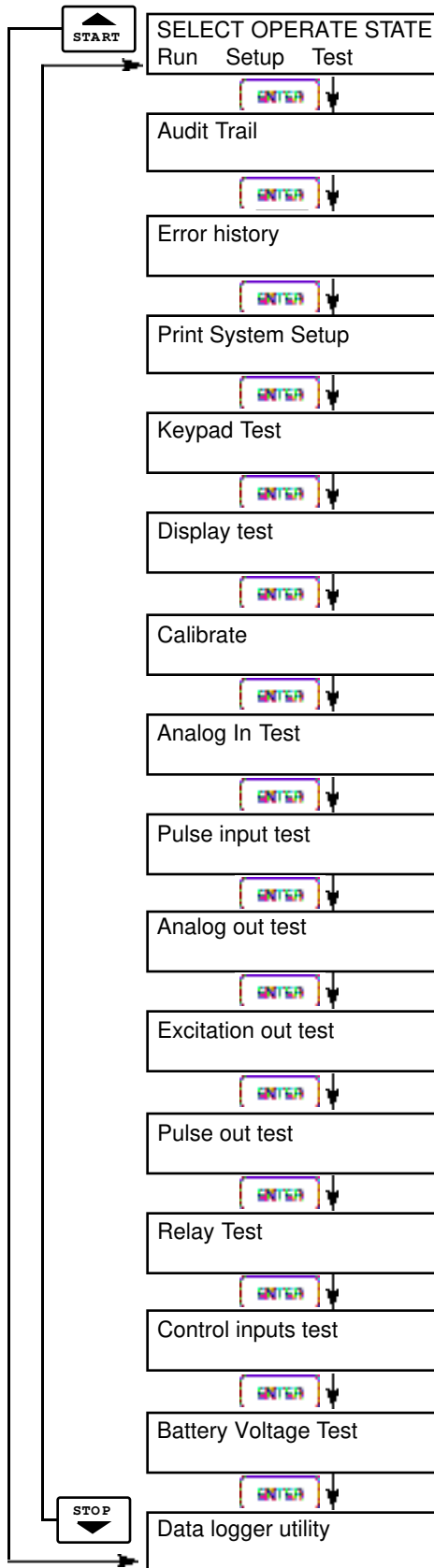

Select Test to enter the instrument test & calibration routine.  
**NOTE:** Supervisor (Service) password required to gain access to this mode.

Refer to Page 44 for Details.

Refer to Page 44 for Details.

Refer to Page 44 for Details.

Refer to Page 45 Details.

Refer to Page 45 for Details.

Refer to Pages 46 -50 for Details.

Refer to Page 50 Details.

Refer to Page 51 for Details.

Refer to Page 51 for Details.

Refer to Page 51 for Details.

Refer to Page 52 for Details.

Refer to Page 52 for Details.

Refer to Page 52 for Details.

Refer to Page 53 for Details.

Refer to Page 53 for Details.

**8.2.1  
Audit Trail  
Submenu Group**

Audit Trail

ENTER ↓

Press Enter to view the audit trail information.

**8.2.2  
Error History  
Submenu Group**

Audit Trail    nnnnn  
hh:mm:ss    mm/dd/yy

ENTER ↓

The audit trail is viewed in this format:  
nnnnn= number of critical menu changes,  
hh:mm:ss; mm/dd/yy = time and date of last change.

Audit Trail

Press Menu to get back to audit trail top-level menu.

**8.2.3  
Print System Setup  
Submenu Group**

Error history

ENTER ↓

Press Enter to view error history.

NOTE: Press Print Key to print Error History. Printout will include time/date of each errors first occurrence.

Error history  
Flow rate alarm low

ENTER ↓

Press Up/Down arrow keys to scroll through error message history. Press CLEAR to clear entire error log.

Error history

Press Menu to get back to error history top-level menu.

Print System Setup

ENTER ↓

Press enter key to enter print system setup submenu

Print System Setup  
Press ENTER to print

ENTER ↓

Press enter to begin printing the system setup.

Print System Setup  
— Printing —

ENTER ↓

This message will display as the data transmission takes place.

Print System Setup

Press Menu to get back to print system setup top-level menu.

**8.2.4  
Keypad test  
Submenu Group**

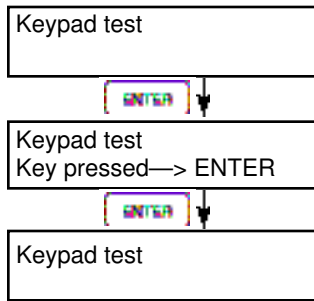

Press Enter to enter keypad test

Press the various keys and the display will show the key that was pressed. Press Menu to exit the test

Press Menu to get back to Keypad test top-level menu.

**8.2.5  
Display test  
Submenu Group**

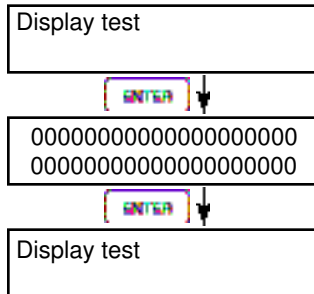

Press Enter to enter display test.

Upon pressing enter each digit on the display will scroll 0-9 then A-Z. Press menu to exit the test.

Press Menu to get back to Display test top-level menu.

**ALL I/O REFERENCES ARE CALIBRATED AT THE FACTORY PRIOR TO SHIPMENT CAUTION:**

This unit must be calibrated using precision and calibrated equipment. Equipment needed is as follows: Frequency Generator, Digital Multimeter, Precision Current/Voltage Source, Oscilloscope, Frequency Counter.

**Calibration Submenu Group**

**8.2.6 Calibrate CH1 0mA Submenu Group**

**8.2.7 Calibrate CH1 20mA Submenu Group**

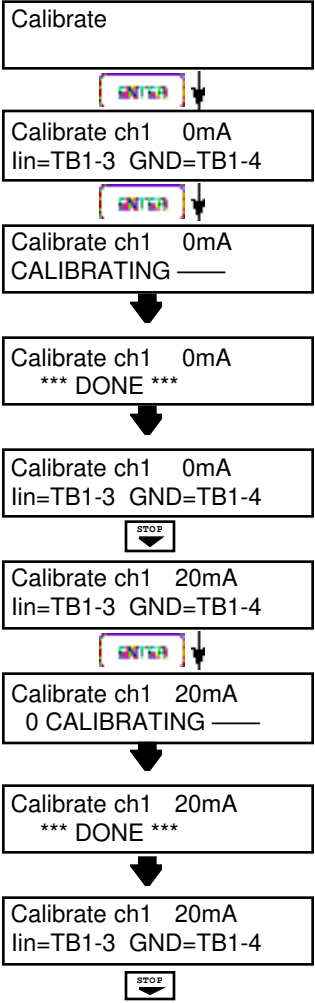

**Advance to**  
Calibrate ch2 0mA

Press Enter to begin the calibration routine. (Please note the caution above)

Connect Current Source (+) TB1-3, (-) TB1-4. Input 0mA and press Enter.

This message is displayed during calibration.

This message is displayed when the 0mA calibration is finished.

The display will automatically return to the Calibrate CH1 0mA submenu. Press the Down arrow key to advance to the CH1 20mA calibration.

Connect Current Source (+) TB1-3, (-) TB1-4. Input 20mA and press Enter.

This message is displayed during calibration.

This message is displayed when the 20mA calibration is finished.

The display will automatically return to the Calibrate CH1 20mA submenu. Press the Down arrow key to advance to the CH2 0mA calibration.

**8.2.8  
Calibrate CH2 0mA  
Submenu Group**

Calibrate ch2 0mA  
lin=TB1-8 GND=TB1-4

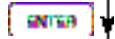

Calibrate ch2 0mA  
0 CALIBRATING —



Calibrate ch2 0mA  
\*\*\* DONE \*\*\*



Calibrate ch2 0mA  
lin=TB1-8 GND=TB1-4



Calibrate ch2 20mA  
lin=TB1-8 GND=TB1-4



Calibrate ch2 20mA  
0 CALIBRATING —



Calibrate ch2 20mA  
\*\*\* DONE \*\*\*



Calibrate ch2 20mA  
lin=TB1-8 GND=TB1-4



**Advance to  
Calibrate ch1 0V**

To Calibrate: Connect Current Source (+) TB1-8, (-) TB1-4. Input 0mA and press Enter.

This message is displayed during calibration.

This message is displayed when the 0mA calibration is finished.

The display will automatically return to the Calibrate CH2 0mA submenu. Press the Down arrow key to advance to the CH2 20mA calibration.

To Calibrate: Connect Current Source (+) TB1-8, (-) TB1-4. Input 20mA and press Enter.

This message is displayed during calibration.

This message is displayed when the 20mA calibration is finished.

The display will automatically return to the Calibrate CH2 20mA submenu. Press the Down arrow key to advance to the CH1 0V calibration.

**8.2.10  
Calibrate CH1 0V  
Submenu Group**

Calibrate ch1 0V  
Vin=TB1-2 GND=TB1-4

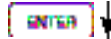

Calibrate ch1 0V  
0 CALIBRATING —

Calibrate ch1 0V  
\*\*\* DONE \*\*\*

Calibrate ch1 0V  
lin=TB1-2 GND=TB1-4



**8.2.11  
Calibrate CH1 10V  
Submenu Group**

Calibrate ch1 10V  
lin=TB1-2 GND=TB1-4



Calibrate ch1 10V  
0 CALIBRATING —

Calibrate ch1 10V  
\*\*\* DONE \*\*\*

Calibrate ch1 10V  
lin=TB1-2 GND=TB1-4



**Advance to**  
Calibrate ch2 0V

To Calibrate: Connect Voltage Source (+) TB1-2, (-) TB1-4. Input 0V and press Enter.

This message is displayed during calibration.

This message is displayed when the 0V calibration is finished.

The display will automatically return to the Calibrate CH1 0V submenu. Press the Down arrow key to advance to the CH1 10V calibration.

To Calibrate: Connect Voltage Source (+) TB1-2, (-) TB1-4. Input 10V and press Enter.

This message is displayed during calibration.

This message is displayed when the 10V calibration is finished.

The display will automatically return to the Calibrate CH1 10V submenu. Press the Down arrow key to advance to the CH2 0V calibration.



**8.2.12**  
**Calibrate CH2 0V**  
**Submenu Group**

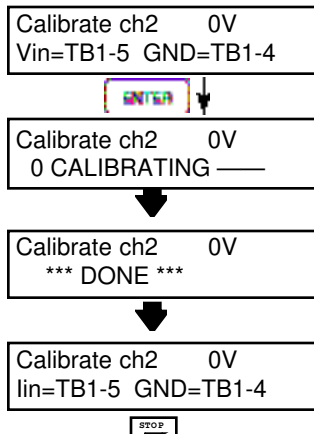

To Calibrate: Connect Voltage Source (+) TB1-5, (-) TB1-4. Input 0V and press Enter.

This message is displayed during calibration.

This message is displayed when the 0V calibration is finished.

The display will automatically return to the Calibrate CH2 0V top-level menu. Press the Down arrow key to advance to the CH2 10V calibration.

**8.2.13**  
**Calibrate CH2 10V**  
**Submenu Group**

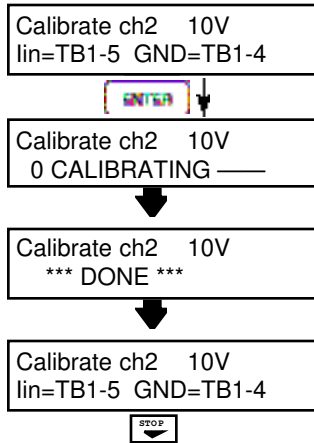

To Calibrate: Connect Voltage Source (+) TB1-5, (-) TB1-4. Input 10V and press Enter.

This message is displayed during calibration.

This message is displayed when the 10V calibration is finished.

The display will automatically return to the Calibrate CH2 10V top-level menu. Press the Down arrow key to advance to the 100 ohm RTD calibration.

**Advance to**  
 Calibrate 100ohm RTD

**8.2.14**  
**Calibrate 100 ohm**  
**RTD**  
**Submenu Group**

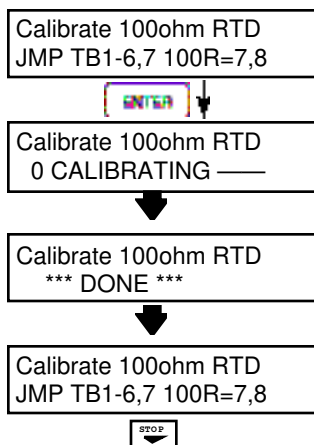

To Calibrate: Connect a jumper wire between TB1-6 and TB1-7, Place a 100 ohm 0.1% resistor between TB1-7 and TB1-8. Press enter to calibrate.

This message is displayed during calibration.

This message is displayed when the RTD calibration is finished.

The display will automatically return to the Calibrate 100 ohm RTD top-level menu. Press the Down arrow key to advance to the 4mA out calibration.

**Advance to**  
 Calibrate 4mA out

**8.2.15  
Calibrate 4mA Out  
Submenu Group**

Calibrate 0mA out  
+ TB1-15 - TB1-16



Calibrate 0mA out  
Enter mA: 0.00000



Calibrate 0mAout  
+ TB1-15 - TB1-16



Calibrate 20mA out  
+ TB1-15 - TB1-16

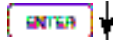

Calibrate 20mA out  
Enter mA: 20.00000

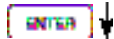

Calibrate 20mAout  
+ TB1-15 - TB1-16



Calibrate

Connect ammeter to (+) TB1-15, (-) TB1-16. Press enter.

To trim 0mA output: Press CLEAR to enable editing and enter a small negative number (i.e. -0.100) to force a display reading, then clear and enter small quantity measured on your meter.

The display will return to Calibrate 0mA out. Press the down arrow key to advance to Cal. 20mA out or repeat above if necessary.

Connect ammeter to (+) TB1-15, (-) TB1-16. Press enter.

To trim 20mA output: Press CLEAR to enable editing and enter the current reading that is on the ammeter display. Press enter.

The display will automatically return to the Calibrate 20mA out submenu. Calibration is complete.

Press the Menu key to go back to Calibrate top-level menu.

**8.2.16  
Calibrate 20mA Out  
Submenu Group**

**8.2.17  
Analog In Test  
Submenu Group**

Analog In Test



Analog In Test Volts  
T2:00.000 T5:00.000



Analog In Test mA  
T3:00.000 T8:00.000



Analog In Test OHMS  
RTD 00.000



Analog In Test

Press enter to test the analog inputs.

To check voltage input accuracy: Use TB1-4 as Reference Ground, input 0-10 Volts to TB1-2 and/or TB1-5. Display should show voltage being input. Use voltage meter to verify input.

To check current input accuracy: Use TB1-4 as Reference Ground, input 0-20mA to TB1-3 and/or TB1-8. Display should show current being input. Use ammeter to verify input.

To check RTD input accuracy: Connect a jumper wire between TB1-6 and TB1-7, Place a 100 ohm 0.1% resistor between TB1-7 and TB1-8. Display should show 100 ohms  $\pm 0.1\%$ .

Press Menu key to return to Analog In Test top-level menu.

**8.2.18**  
**Pulse input test**  
**Submenu Group**

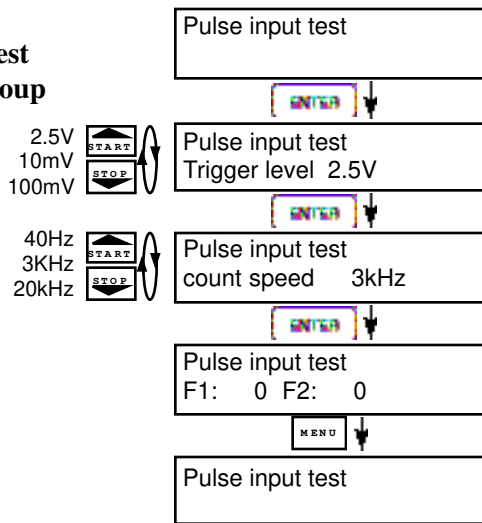

Press Enter key to test the pulse input.

Use the Up/Down arrow keys to select the appropriate trigger level.

Use the Up/Down arrow keys to select the appropriate frequency range.

To check Pulse input accuracy: Use TB1-4 as reference ground, input a frequency on TB1-2. The display should show frequency being input. Use a frequency counter to verify input.

Press Menu key to return to Pulse input test top-level menu.

**8.2.19**  
**Analog out test**  
**Submenu Group**

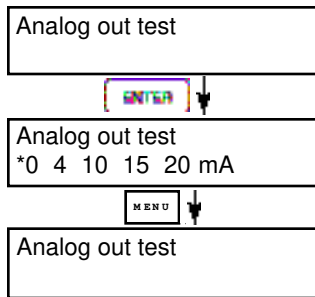

Press Enter to test the analog output.

To simulate analog output: Connect an ammeter to (+) TB1-15, (-) TB1-16. Press the key under the desired setting to move the asterisk (\*). The unit should output the selected current.

Press Menu key to return to Analog out test top-level menu.

**8.2.20**  
**Excitation out test**  
**Submenu Group**

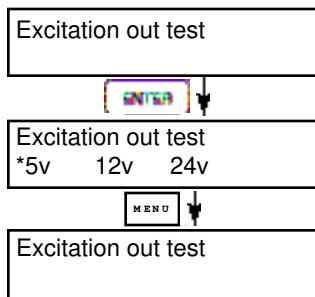

Press Enter to test the excitation output.

To test the excitation output: Connect a voltmeter to (+) TB1-1, (-) TB1-4. Press the key under the desired setting to move the asterisk (\*). The unit should output the selected voltage.

Press Menu key to return to Excitation out test top-level menu.

**8.2.21**  
**Pulse out test**  
**Submenu Group**

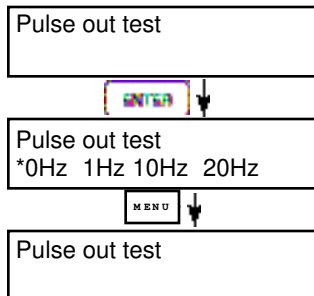

Press Enter key to test the pulse output.

To simulate a frequency on the pulse output: Connect a frequency counter to (+)TB1-13, (-)TB1-14. Press the key under the desired setting to move the asterisk (\*). The unit should output the selected frequency.

Press Menu key to return to Pulse out test top-level menu.

**8.2.22**  
**Relay test**  
**Submenu Group**

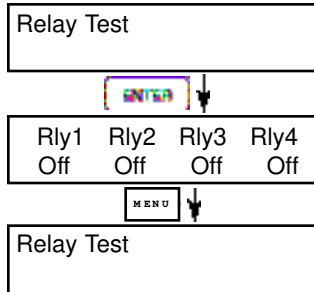

Press Enter to test the relays.

To manually control the relay outputs: Press the key under the desired relay to toggle the relays On/Off. Use an ohmmeter to check the relay contacts.

Press Menu key to return to Relay Test top-level menu.

**8.2.23**  
**Control input test**  
**Submenu Group**

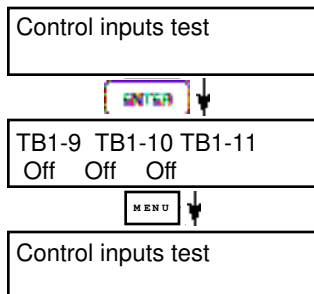

Press Enter to test the control inputs.

To check the control inputs: Use TB1-12 as reference, input a D signal to TB1-9, TB1-10 and/or TB1-11, The Display will show ( ) when input is active, OFF when inactive.

Press Menu key to return to control input test top-level menu.

**8.2.24**  
**Battery Voltage**  
**test**  
**Submenu Group**

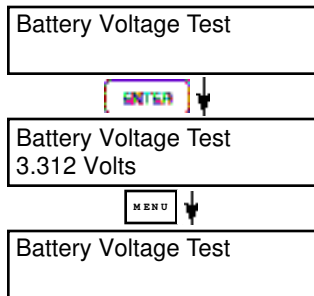

Press Enter key to view the battery voltage.

The display will show the battery voltage.  
Replace battery at 2.5 VDC or below.

Press Menu key to return to battery voltage test top-level menu.

**8.2.25**  
**Data logger utility**  
**Submenu Group**

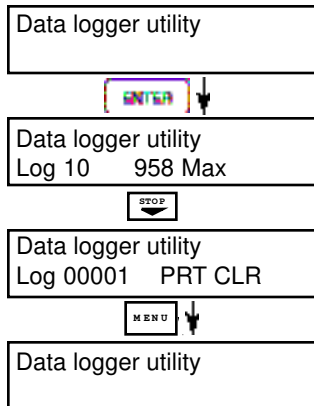

Press Enter to use data logger utility.

The displays shows the number of Data Logs.  
Press the Down arrow key to advance to PRT (print) or CLR (clear).

Press PRINT key to output data logger logs to printer,  
Press CLEAR key to clear the data logger contents.

Press Menu key to return to Data logger utility top-level menu.

## 8.3 Internal Fuse Replacement

### Instructions:

1. Make sure you follow proper E.S.D. Precautions. All persons performing this replacement must follow proper grounding procedures.
2. Turn the power to the unit off.
3. Disconnect the two piece connector rear terminal block, leaving all connections in place.
4. Remove the unit from the panel.
5. Remove the four machine screws (see fig. 1) which hold the two sections of the case together.
6. The rear section of the case should detach from the rest of the case. It may be necessary to cut the wiring label along the joint where the two sections connect. With the rear section of the case removed the fuse will be exposed (located near the rear terminal, AC connection).
7. Locate the Fuse F1 (see fig. 2) and unplug the fuse from its socket.
8. Insert the new fuse into the socket. Insure that the pins are fully inserted and straight.
9. Reassemble the case and install the four machine screws which join the two sections of the case.
10. Reinstall the unit into the panel.
11. Reconnect the rear terminal block.
12. Turn the unit back on.

### Fuse Specifications:

110 VAC Power:	160mA/250V, TD Wickman 19372-030-k or equivalent
220 VAC Power:	80mA/250V, TD Wickman 19372-026-k or equivalent
12/24 VDC Power:	800mA/250V, TD Wickman 19374-046-k or equivalent

Fig. 1

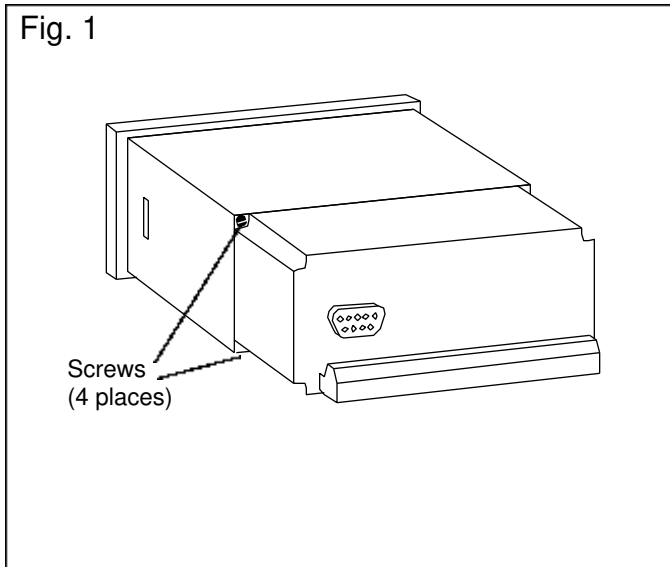
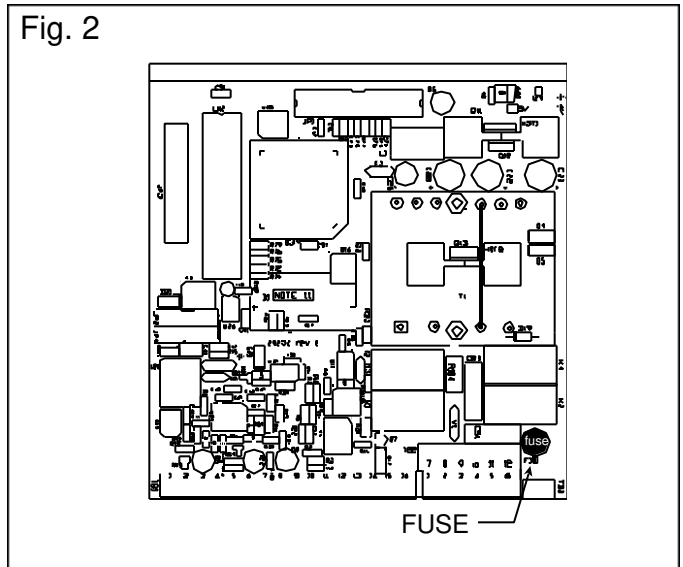

Fig. 2



## 9. RS-232 SERIAL PORT

### 9.1 RS-232 Port Description:

The Model 121 Series has a general purpose RS-232 Port which may be used for any one of the following purposes:

- Transaction Printing
- Data Logging
- Remote Metering by Modem (optional)
- Computer Communication Link
- Configuration by Computer
- Print System Setup
- Print Calibration/Malfunction History

### 9.2 Instrument Setup by PC's over Serial Port

A Diskette program is provided with the Model 121 Series that enables the user to rapidly configure the unit using a Personal Computer. Included on the diskette are common instrument applications which may be used as a starting point for your application. This permits the user to have an excellent starting point and helps speed the user through the instrument setup.

### 9.3 Operation of Serial Communication Port with Printers

The Model 121's RS-232 channel supports a number of operating modes. One of these modes is intended to support operation with a printer in metering applications requiring transaction printing, data logging and/or printing of calibration and maintenance reports.

For transaction printing, the user defines the items to be included in the printed document. The user can also select what initiates the transaction print generated as part of the setup of the instrument. The transaction document may be initiated via a front panel key depression, a remote contact closure, or upon completion of a batch.

In data logging, the user defines the items to be included in each data log as a print list. The user can also select when or how often he wishes a data log to be made. This is done during the setup of the instrument as either a time of day or as a time interval between logging.

The system setup and maintenance report list all the instrument setup parameters and usage for the current instrument configuration. In addition, the Audit trail information is presented as well as a status report listing any observed malfunctions which have not been corrected.

The user initiates the printing of this report at a designated point in the menu by pressing the print key on the front panel. The user may specify a "next calibration date" for periodic maintenance. The unit will automatically remind the user that calibration is scheduled during instrument power up and in some printed documents after that date.

### 9.4 121 Series RS-232 Port Pinout

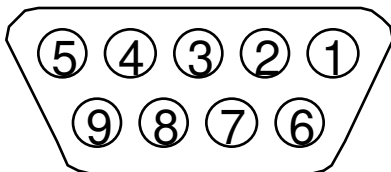

- 1 Handshake Line
- 2 Transmit
- 3 Receive
- 4 Do Not Use
- 5 Ground
- 6 Do Not Use
- 8 Do Not Use
- 9 Do Not Use

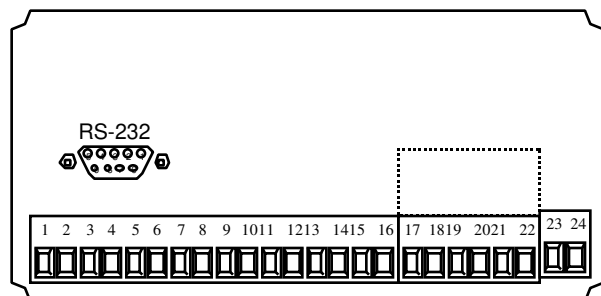

## 11. Flow Computer Setup Software

The Model 121 setup program provides for configuring, monitoring and controlling the indicator.

Sample applications are stored in disk files. The setup program calls these Templates. You can store the setup from the program's memory to either the Model 121 (Downloading the file) or to a disk file (Saving the file) for later usage. Similarly you can load the setup in program memory from either a disk file (Opening a file) or from the Model 121 unit (Uploading a file).

The program can monitor outputs from the unit while it is running.

The program can reset alarms and totalizers.

For assistance there are mini-helps at the bottom of each screen in the program. There is also context sensitive help available for each screen accessible by pressing the F1 key.

### 11.1 System Requirements:

IBM PC or compatible with 386 or higher class microprocessor

4 MB RAM

3 MB free disk space

VGA or higher color monitor at 640 x 480

Microsoft® Windows™ 3.1 or 3.11 or Windows 95™

Communication Port - RS-232

RS-232 Cable

### 11.2 Cable and Wiring Requirements:

The serial communication port on your PC is either a 25 pin or 9 pin connector. No cabling is supplied with the setup software. A cable must be purchased separately or made by the user. It is recommended to purchase a modem cable which matches the available communication port on you PC and a 9 pin male connection for the Model 121 serial port.

### 11.3 Installation for Windows™ 3.1 or 3.11

The Setup Software includes an installation program which copies the software to your hard drive.

Insert Setup Disk 1 in a floppy drive.

In the Program Manager, click File, and then select Run.

NOTE: For Windows 95™ Click the Start button, select Run and proceed as follows:

Type the floppy drive letter followed by a colon (:), and a backslash (\), and the word setup. For Example:

a:\setup

Follow the instructions on your screen.

### 11.4 Using the Flow Computer Setup Software

The setup software window consists of several menu "Tabs". Each tab is organized into groups containing various configuration and/or monitoring functions. To view the tab windows, simply click on the tab. The previous tab window will be hidden as the new tab window is brought to the foreground.



## 11.5 File Tab

The File Tab has three sections. Any of the options on this tab can also be accessed from the File submenu.

The **Template Section** provides for opening and saving templates. The Save and Save As buttons provide the standard Windows functionality for dealing with files. The Load button is used to open existing templates.

There are two additional menu items available only from the File menu: Create new file and Templates.

The *Create new file*, option allows for creating custom templates using the existing template in memory as the starting point. Assign a new name for this template. The template will be saved under this new name.

The *Template* option will bring up a list of predefined templates that can be loaded into the program. These predefined templates are useful as a starting point when defining custom templates.

A typical scenario using the setup program would be the following:

- Open up a predefined template from the supplied list
- Choose 'Save As' to save this to a new file name
- Proceed to customize the template by making any changes that are needed
- Save the template to disk (if you want to reuse this template)
- Download the template to an attached unit.

The **Communications with Model 121** Section allows the user to upload a template file from the unit, download the program's current template to the unit or Compare the program's current template with the unit.

The **Print (report) Section** allows the user to:

1. Configure the current Windows™ printer through the Select Printer option.
2. Print a Maintenance Report through the PC's printer using the Print Maintenance option.
3. Print the current template through the PC's printer using Print Setup option.

## 11.6 Setup Tab

The Setup tab is where majority of the 121 Series instrument setup modifications are done. The Setup tab is divided into five sections.

<b>System Section:</b>	Parameters, Display, Indicators
<b>Input Section:</b>	Flow, Fluid, Compensations, Control Inputs
<b>Output Section:</b>	Pulse, Currents
<b>Relay Section:</b>	Relays
<b>Other Settings Section:</b>	Administration, Communication, Printing

**NOTE:** Many setup items are enabled or disabled depending on previous setup selections, It is important to work your way through the above list in the order shown. Be sure to verify your selections when you are through programming to insure that no settings were changed automatically.

## 11.7 View Tab

The View Tab screen allows for viewing selected group items on the PC in a similar format as shown on the unit display. Data from the following groups can be viewed in the List of Values section:

Process Parameters (i.e. rate, temperature)

Totalizers (i.e. total, grand total)

The setup software assumes the current setup has been uploaded from the flow computer into the PC. It is important that the setup program and the Model 121 unit are using the same setup information at all times or the data will be inconsistent. **It is best to upload or download the setup before using this feature.**

To start the viewer, first check the boxes of items to view and then click the start button. The data will appear in the appropriate sections and will be continuously updated. The refresh rate is dependent on the number of items that are being viewed and the baud rate of the connection. Data in the List of Values section can be collapsed by clicking on the 'minus' sign in front of the group title. The data can be expanded by clicking on the 'plus' sign in front of the group title. If a group is collapsed and data in the group changes on refresh, the group will automatically expand. Changing the view items requires stopping the current viewing, checking the new selections and then restarting the viewer.

If communication errors occur while reading data from the indicator, the word 'Error' will appear in place of the actual value. If the connection to the 121 Series is lost, the viewer will time out with a message saying the device is not responding.

The viewer will attempt to communicate with the indicator matching the device ID set in the communications screen. If you are having trouble establishing communication, compare settings for the PC and the flow computer. Also verify the connections between the PC and flow computer.

## 11.8 Misc. Tab

This tab has three sections: Tools, Actions and Options.

The tools section contains various system administration activities such as creating/modifying the initial sign-on screen or calibration, service test etc.

Create Sign-on, Create Print Header, Calibration, Service Test

The Actions section is used to send commands to the Model 121.

Reset Totalizers, Reset Alarms

The Options section has the following selections:

Linearization, PC Communication

Additional capabilities may be provided in the future.

**NOTE:** Future options appear as disabled buttons on the screen.

## 12. Glossary Of Terms

### **Acknowledge & Clear Alarms**

Acknowledge is used to clear alarm relays and remove any visual alarm messages from the display. In the run mode, press the ENTER key or activate CONTROL INPUT 3 (if set for ACK) to momentarily clear alarms and alarm messages. Alarms will reassert themselves if alarm conditions are still present.

### **Analog Output**

The analog signal (4-20mA) that is generated by the Model 121. It can correspond to the Rate, Total, Temperature or Density. This output is used primarily for transmission of process information to remote systems.

### **Audit Trail**

The audit trail is used to track the number of changes made to the units setup program.

### **Auto Batch Restart**

The Auto Batch Restart function allows the user to set an amount of time to automatically restart a batch after the completion of a batch. This time can be set from 1 to 99 seconds.

### **Batch Count Mode**

Batch Count Mode specifies the user preference for count direction. The "Up" selection begins with a value of "0" and counts up until the batch size is reached. The "Down" selection begins with a value equal to the desired batch size and counts down to "0".

### **Batch Overrun**

The Model 121 offers a batch overrun compensation routine. If batch overrun occurs due to slow valve response time, the unit will compensate for the overrun amount on the next batch. This feature can be disabled if desired.

### **Batcher**

An instrument which controls the dispensing of desired batch amounts. Liquid batching systems are usually comprised of a batch controller (batcher), flowmeter and control valve. The batcher opens and closes the valve through the use of relays and measures the amounts of liquid being dispensed via the flowmeter.

### **Baud Rate**

The speed of serial communication transmissions, expressed in bits per second.

### **C-Factor (Fluid Expansion Factor)**

A parameter in a flow equation which is used to describe the relationship between density or volume and temperature changes.

### **Corrected Volume Flow**

The equivalent volume at a reference temperature condition which involves the measurement of liquid volume flow using a flow sensor and temperature sensor to compensate for thermal expansion.

### **Custody Transfer**

Weights and Measure metering codes often specify several requirements for instruments and mechanisms to prevent and track changes in the setup of an instrument which may be used in the commercial sale of goods. The Model 121 tracks changes via the Audit Trail.

### **Data Logger**

The capturing of information for printing out later use and the mechanism for specifying the conditions where a capture should be made.

### **DC Output / Excitation Voltage**

An on-board DC power supply used to power peripheral sensors. The Model 121 offers excitation voltages of 5VDC, 12VDC or 24VDC when powered by AC voltage.

### **Default Value**

The value to be used by the instrument if a sensor failure or out of range signal is detected.

### **Expansion Factor**

See C-Factor

### **Flow Alarm**

A visual indication that the volumetric flowrate is above or below the flow alarm setpoint specified by the user.

## 12. Glossary Of Terms (Continued)

### Flow Signal Timeout

The Flow Signal Timeout allows the user to enter a timeout of 0 to 99 seconds. If a batch is "Filling" and zero flow persists for more than the user entered time then the batch will be aborted. This prevents over flows due to faulty flow sensors and/or wiring.

### Flow Equation

A flow control expression or algorithm describing a mathematical equation to be solved by a flow computer in the desired application.

### Follow, Alarm

Alarm relays which are non latching and whose output state is based solely on the comparison of the current process value and the alarm setpoint (trip point).

### Function Key

A key on a push-button panel or keyboard (whose function is described by the key label) used to perform an instrument function or special routine.

### Handshake

A means of controlling the information flow between two pieces of equipment to prevent the sending device from transmitting information at a rate faster than what can be accepted by the receiver.

### Hysteresis

The relay hysteresis is a "dead band" setting which allows the relay to remain energized for a given amount below the setpoint. This is used to prevent relay chatter when the process value is near the setpoint value.

Example: If the Preset is set at 100, and the hysteresis is set at 10, the relay will energize when the rate, temp or dens. reaches 100, the relay will remain energized until the reading falls below 90.

### Input Termination

Input signal lines on digital inputs often require pullup or pulldown resistor configurations to operate properly with different sensor configurations. The Model 121 contains such resistors and may be enabled via the setup menu.

### Inhibit Totalizer

"Inhibit Total" is a Control Input 1 setting that is used to stop the totalization. If enabled, a voltage level on control input 1 will inhibit the total as long as the voltage is present. This feature is useful during meter proving and in applications that provide a sensor to signal the flow computer when fluid is present.

### K-Factor

A scaling factor derived from the pulses produced by a flowmeter output, expressed in pulses per unit (i.e. pulses/gallon)

### Limit Setpoint

An alarm trip point setting which specifies the value or magnitude of a process parameter necessary to activate an alarm indicator or control relay.

### Linear Flowmeter

A flow measurement device whose output is proportional to flow.

### Linearization

The mathematical correction of a nonlinear device. The Model 121 uses a linearization Table which is made up of input/output values and makes interpolations of the table to arrive at a "linearized" measurement.

### LinTbl

Abbreviation for Linearization Table.

### Low Flow Cutoff

A value set at which any flow measurements read below this value will be ignored.

### Low Pass Filter

A low pass filter passes low input frequencies while blocking high frequencies. In the Model 121, this is the maximum input count speed to be encountered in an application. It is expressed in counts per second (Hz).

### Mass Flow

Mass Flow is inferred by the volumetric flow and density (or implied density) of a fluid.

## 12. Glossary Of Terms (Continued)

### Maximum Batch Preset

The Maximum Batch Preset allows the user to program the Maximum Batch value allowed to be entered by the operator. If an operator should try to program a batch higher than this value, the unit will not allow the value to be entered and will prompt the user with an error message saying that the Maximum Batch Preset has been exceeded.

### Maximum Drain Time

The unit declares that a batch is "done" when the flow rate equals "0". A flow rate may be present long after the Preset Relay de-energizes due to slow reacting valves or leaky valves. The Maximum Drain Time allows the user to enter an amount of time (0 to 99 seconds) to wait before declaring "Batch Done". After the Preset Batch quantity is reached, the unit will declare "Batch Done" when the flow rate is "0" or the Maximum Drain Time has expired. The batch data will then be available for printing and datalogging.

### Max Window

The max. window time sets the maximum sample time (1 to 99 sec) for the ratemeter.

### Modem Init Master

The "Modem Init Master" menu allows the user to select whether the unit will engage in a configuration conversation with the modem on power up or impart no setup information to the modem and use it "as is". For most users it is recommended to choose "yes" for "Modem Init Master".

### Parity

A method for detecting errors in transmissions of serial communications data.

### Preset

A set point used to trigger the relay outputs of the 121 Series.

### Print Interval

The print interval allows the 121 Series to transmit information to the serial port at selectable time intervals.

### Private Code

An operator password code which authorizes changes to the setup of the instrument but blocks access to the Service/Calibration/Test mode. The private code also blocks the clearing of the Grand Total.

### Process Parameters

Any sensor information which has been scaled to engineering units including Flow, Temperature and Density.

### Pulldown (Input Termination)

The termination of an input at which the input is pulled down to ground through a resistor. Inputs that are terminated by this method need to be driven high with a positive voltage pulse.

### Pullup (Input Termination)

The termination of an input at which the input is pulled up to a positive voltage through a resistor. Inputs that are terminated by this method need to be pulled low with a sinking current or contact to ground.

### Pulse Output

The pulse output of the 121 Series is available for remote accumulation of the total or sent to peripheral devices, such as a PLC. The output can be scaled using the Pulse Output Scaling Constant.

### Quad

Abbreviation for Quadrature. Quadrature signals are used for direction control. Two flowmeter signals are output with a 90° phase shift. The counter counts UP when channel A precedes channel B, and counts DOWN when Channel A lags Channel B.

### Quick Setup

A utility that provides for rapid configuration of an instrument. The Model 121 quick setup provides the following:

- 1) Prompts the user for only critical information.
- 2) Automatically sets specifications to common uses.

After following the Quick Setup procedure, the unit will be operational to perform the basic measurement. The setup can be further customized using the setup menus.

## 12. Glossary Of Terms (Continued)

### **Quick Update %**

This feature is used to disable the rate averaging filter when a significant change in the flow rate occurs. The user can enter the percent of change needed to be detected to disable the averaging feature. This is especially useful during start-up and shutdown of flow.

### **Rate Averaging Filter**

The rate averaging filter is used to stabilize fluctuating rate displays. Higher settings provide more averaging for a more stable display. Derived from the equation:

$$\frac{(\text{OLD DATA} \times \text{"Avg. Filter"} + \text{NEW DATA})}{(\text{"Avg. Filter"} + 1)}$$

### **Ratometer**

Any device used to display the speed of a process. The ratemeter in the Model121 Series displays flow rate.

### **Ref. Dens.**

Abbreviation for Reference Density. This is the fluid density at reference temperature.

### **Ref. Temp.**

Abbreviation for Reference Temperature. This represents the base or reference condition to which corrected flow will be computed.

### **Reset/Start Control Input**

In a batching system, a single operator activation of the START key or Control Input 1 will reset the total then start the batch process.

### **Single\_Pulse**

The Single\_Pulse setting is used for flowmeters with single pulse outputs.

### **Slow Start Quantity**

The Slow Start Quantity is a function that allows an amount to be entered for a Slow Start up. This function requires two stage valve control. RLY 1 (slow flow) will energize for Slow Start and RLY 2 (fast flow) will energize after the Slow Start Quantity has been delivered. This helps reduce turbulence when filling an empty container.

### **Sqrt**

Abbreviation for Square Root Extraction. Used for flow elements using differential pressure measurements.

### **Stop/Reset Control Input**

In a batching system, a single operator activation of the STOP key or Control Input 2 will stop the batch process then reset the total.

### **Time Constant**

A damping factor for an averaging filter for the analog output. (see also Rate Averaging Filter)

### **Totalizer**

Any device which accumulates and displays a total count.

### **UVC**

Abbreviation for Universal Viscosity Curve. A presentation of the combined flowrate/viscosity calibration for a turbine flowmeter.

### **VFD**

Abbreviation for Vacuum Fluorescent Display

### **Visc Coef**

Abbreviation for Viscosity Coefficient. One or more coefficients in an equation used to describe the viscosity as a function of temperature for a fluid.

### **Volume Flow**

The measurement of volumetric flow.

## 13. Diagnosis and Troubleshooting

### 13.1 Response of Model 121 on Error or Alarm:

Error and warning indications which occur during operation are indicated in the RUN mode alternately with the measured values. The Model 121 Flow Computer has three types of error:

TYPE OF ERROR	DESCRIPTION
Sensor/Process Alarms	Errors detected due to sensor failure or process alarm conditions
Self Test Errors	Errors detected during self test.
System Alarms	Errors detected due to system failure

Some alarms are self clearing. Other alarms require the user to acknowledge and clear the alarm. Press the ENTER button to acknowledge and clear alarms. Alarms may reassert themselves if the alarm condition is still present.

**NOTE:** A historical error alarm log is available in the "Test Mode".

The following descriptions suggest possible causes and corrective actions for each alarm message.

## 13.2 Diagnosis Flow Chart and Troubleshooting

A summary of possible causes is given below to help you identify faults.

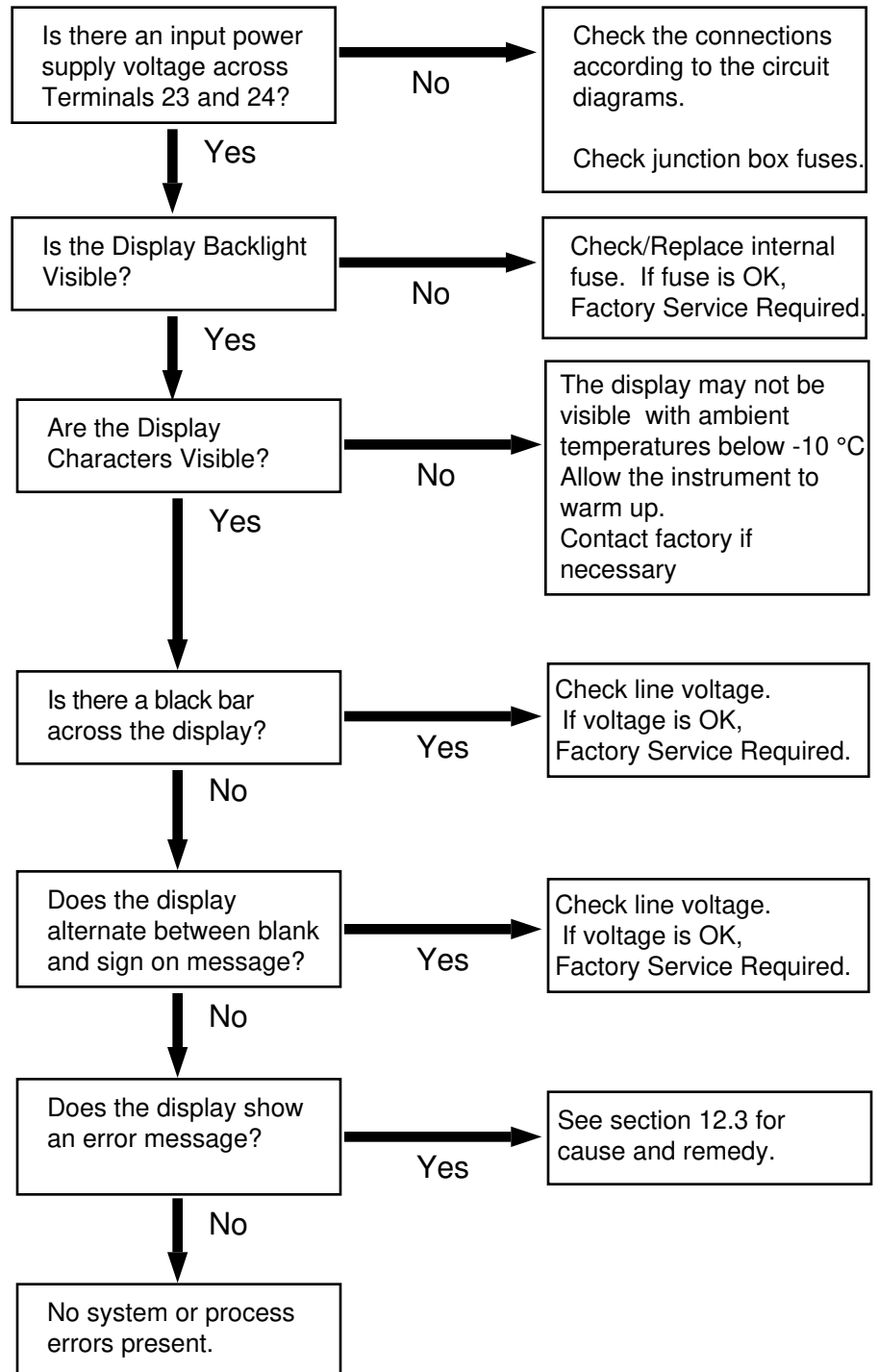



## 13.2 Diagnosis Flow Chart and Troubleshooting

### 13.3.1

#### Sensor/Process Alarms

Error/Warning Message	Cause	Remedy
<b>TOTALIZER ROLLOVER</b>	Displayed when totalizer rolls over	Acknowledge Rollover, Remedy not required
<b>AUX INPUT TOO LOW</b>	4-20 mA Input current at aux input smaller than 3.5 mA: <ul style="list-style-type: none"> <li>• Faulty Wiring</li> <li>• Transmitter not set to "4-20 mA"</li> <li>• Transmitter defective</li> </ul>	<ul style="list-style-type: none"> <li>• Check wiring</li> <li>• Check function of sensor</li> </ul>
<b>RTD OUT OF RANGE</b>	Input current at RTD input too low: <ul style="list-style-type: none"> <li>• Faulty wiring</li> <li>• RTD defective</li> </ul>	<ul style="list-style-type: none"> <li>• Check wiring</li> <li>• Check function of RTD sensor</li> </ul>
<b>RATE OVERFLOW ERROR</b>	Pulse counter overflowed. The totalizer may have lost counts.	<ul style="list-style-type: none"> <li>• Report error to factory</li> <li>• Check application conditions</li> <li>• Check wiring</li> </ul>
<b>PULSE OUT OVERFLOW</b>	Calculated pulse frequency too large: <ul style="list-style-type: none"> <li>• Pulse width setting too long</li> <li>• Larger pulse scaler needed</li> </ul>	<ul style="list-style-type: none"> <li>• Adjust pulse value</li> <li>• Adjust pulse width</li> <li>• Check process conditions</li> </ul>
<b>FLOW RATE ALARM LOW</b> <b>FLOW RATE ALARM HIGH</b> <b>TEMP ALARM LOW</b> <b>TEMP ALARM HIGH</b> <b>DENSITY ALARM LOW</b> <b>DENSITY ALARM HIGH</b>	Limit value exceeded.	<ul style="list-style-type: none"> <li>• Check application if necessary</li> <li>• Check limit value</li> <li>• Adjust the limit value if required</li> </ul>
<b>BATCH OVERRUN ALARM</b>	Batch size exceeded by more than set limit.	<ul style="list-style-type: none"> <li>• Check valves in system for proper operation and/or leaks</li> <li>• Check limit value</li> <li>• Adjust the limit value if required</li> </ul>
<b>MODEM NOT PRESENT</b>	The setup expects modem usage and a modem is not responding.	<ul style="list-style-type: none"> <li>• Check setup for proper baud rate, parity, etc.</li> <li>• Check modem connection and cycle power</li> <li>• Replace modem</li> </ul>
<b>SOFTWARE ERROR</b> <b>RESET</b>	Abnormal program termination may have occurred as a result of power transient.	<ul style="list-style-type: none"> <li>• Clear error</li> <li>• Verify instrument setup</li> <li>• Cycle power</li> <li>• Additional filtering may be required on power input</li> </ul>
<b>EXTENDED PFI LOCKUP</b>	Unit was operated with an input power level lower than safe operating range for an extended period of time.	<ul style="list-style-type: none"> <li>• Check data in unit. Totalizer may have inaccuracies</li> <li>• Investigate brownout cause.</li> </ul>

## 13.2 Diagnosis Flow Chart and Troubleshooting

### 13.3.2 Self Test Alarms

Error/Warning Message	Cause	Remedy
<b>FLOW INPUT TOO HIGH</b>	Analog input signal of the flow input exceeded by more than 3%: <ul style="list-style-type: none"> <li>• Sensor overranged</li> <li>• Incorrect full scale setting of flowmeter</li> <li>• Function error in transmitter or faulty wiring</li> </ul>	<ul style="list-style-type: none"> <li>• Check analog signal range</li> <li>• Check the application conditions</li> <li>• Check wiring</li> </ul>
<b>AUX INPUT TOO HIGH</b>	Analog input signal of the auxiliary input exceeded by more than 3%: <ul style="list-style-type: none"> <li>• Sensor overranged</li> <li>• Incorrect full scale setting of transmitter</li> <li>• Function error in transmitter or faulty wiring</li> </ul>	<ul style="list-style-type: none"> <li>• Check analog signal range</li> <li>• Check the application conditions</li> <li>• Check wiring</li> </ul>
<b>FLOW INPUT TOO LOW</b>	Analog input signal of the flow input fell below the low scale range by more than 3% of full scale value: <ul style="list-style-type: none"> <li>• Flowmeter not set to 4-20 mA</li> <li>• Function error in transmitter or faulty wiring</li> </ul>	<ul style="list-style-type: none"> <li>• Check wiring</li> <li>• Check calibration of flowmeter</li> <li>• Check function of flowmeter</li> </ul>
<b>BATTERY LOW WARNING</b>	Battery voltage too low	<ul style="list-style-type: none"> <li>• Replace Battery</li> <li>• Consult Factory for service information</li> </ul>
<b>A to D NOT CONVERTING</b>	Fault in analog/digital converter	<ul style="list-style-type: none"> <li>• Unit may self correct, Press ENTER to acknowledge &amp; clear alarm</li> <li>• If error reasserts, factory service is required</li> </ul>
<b>TIME CLOCK ERROR</b>	The correct time/date is no longer shown	<ul style="list-style-type: none"> <li>• Re-enter time and date.</li> <li>• If error occurs again contact factory</li> </ul>
<b>CAL CHECKSUM ERROR</b>	Calibration constants have been corrupted	<ul style="list-style-type: none"> <li>• Report error to factory</li> </ul>
<b>SETUP CHECKSUM ERROR</b>	The units setup has been corrupted	<ul style="list-style-type: none"> <li>• Report error to factory</li> </ul>

